



HTR-5830

AV Receiver

OWNER'S MANUAL

IMPORTANT SAFETY INSTRUCTIONS

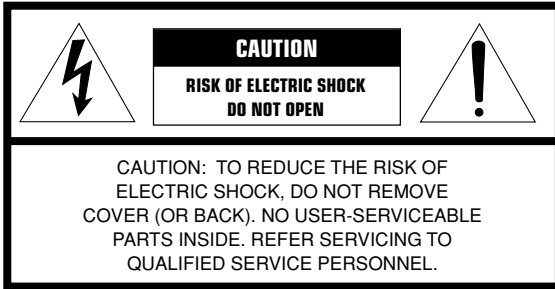

• Explanation of Graphical Symbols

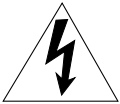

The lightning flash with arrowhead symbol, within an equilateral triangle, is intended to alert you to the presence of uninsulated “dangerous voltage” within the product’s enclosure that may be of sufficient magnitude to constitute a risk of electric shock to persons.



The exclamation point within an equilateral triangle is intended to alert you to the presence of important operating and maintenance (servicing) instructions in the literature accompanying the appliance.

- 1 Read Instructions – All the safety and operating instructions should be read before the product is operated.
- 2 Retain Instructions – The safety and operating instructions should be retained for future reference.
- 3 Heed Warnings – All warnings on the product and in the operating instructions should be adhered to.
- 4 Follow Instructions – All operating and use instructions should be followed.
- 5 Cleaning – Unplug this product from the wall outlet before cleaning. Do not use liquid cleaners or aerosol cleaners. Use a damp cloth for cleaning.
- 6 Attachments – Do not use attachments not recommended by the product manufacturer as they may cause hazards.
- 7 Water and Moisture – Do not use this product near water – for example, near a bath tub, wash bowl, kitchen sink, or laundry tub; in a wet basement; or near a swimming pool; and the like.
- 8 Accessories – Do not place this product on an unstable cart, stand, tripod, bracket, or table. The product may fall, causing serious injury to a child or adult, and serious damage to the product. Use only with a cart, stand, tripod, bracket, or table recommended by the manufacturer, or sold with the product. Any mounting of the product should follow the manufacturer’s instructions, and should use a mounting accessory recommended by the manufacturer.
- 9 A product and cart combination should be moved with care. Quick stops, excessive force, and uneven surfaces may cause the product and cart combination to overturn.
- 10 Ventilation – Slots and openings in the cabinet are provided for ventilation and to ensure reliable operation of the product and to protect it from overheating, and these openings must not be blocked or covered. The openings should never be blocked by placing the product on a bed, sofa, rug, or other similar surface. This product should not be placed in a built-in installation such as a bookcase or rack unless proper ventilation is provided or the manufacturer’s instructions have been adhered to.
- 11 Power Sources – This product should be operated only from the type of power source indicated on the marking label. If you are not sure of the type of power supply to your home, consult your product dealer or local power company. For products intended to operate from battery power, or other sources, refer to the operating instructions.
- 12 Grounding or Polarization – This product may be equipped with a polarized alternating current line plug (a plug having one blade wider than the other). This plug will fit into the power outlet only one way. This is a safety feature. If you are unable to insert the plug fully into the outlet, try reversing the plug. If the plug should still fail to fit, contact your electrician to replace your obsolete outlet. Do not defeat the safety purpose of the polarized plug.
- 13 Power-Cord Protection – Power-supply cords should be routed so that they are not likely to be walked on or pinched by items placed upon or against them, paying particular attention to cords at plugs, convenience receptacles, and the point where they exit from the product.
- 14 Lightning – For added protection for this product during a lightning storm, or when it is left unattended and unused for long periods of time, unplug it from the wall outlet and disconnect the antenna or cable system. This will prevent damage to the product due to lightning and power-line surges.
- 15 Power Lines – An outside antenna system should not be located in the vicinity of overhead power lines or other electric light or power circuits, or where it can fall into such power lines or circuits. When installing an outside antenna system, extreme care should be taken to keep from touching such power lines or circuits as contact with them might be fatal.
- 16 Overloading – Do not overload wall outlets, extension cords, or integral convenience receptacles as this can result in a risk of fire or electric shock.
- 17 Object and Liquid Entry – Never push objects of any kind into this product through openings as they may touch dangerous voltage points or short-out parts that could result in a fire or electric shock. Never spill liquid of any kind on the product.
- 18 Servicing – Do not attempt to service this product yourself as opening or removing covers may expose you to dangerous voltage or other hazards. Refer all servicing to qualified service personnel.
- 19 Damage Requiring Service – Unplug this product from the wall outlet and refer servicing to qualified service personnel under the following conditions:
 - a) When the power-supply cord or plug is damaged,
 - b) If liquid has been spilled, or objects have fallen into the product,
 - c) If the product has been exposed to rain or water,



- d) If the product does not operate normally by following the operating instructions. Adjust only those controls that are covered by the operating instructions as an improper adjustment of other controls may result in damage and will often require extensive work by a qualified technician to restore the product to its normal operation,
 - e) If the product has been dropped or damaged in any way, and
 - f) When the product exhibits a distinct change in performance - this indicates a need for service.
- 20 Replacement Parts – When replacement parts are required, be sure the service technician has used replacement parts specified by the manufacturer or have the same characteristics as the original part. Unauthorized substitutions may result in fire, electric shock, or other hazards.
- 21 Safety Check – Upon completion of any service or repairs to this product, ask the service technician to perform safety checks to determine that the product is in proper operating condition.
- 22 Wall or Ceiling Mounting – The unit should be mounted to a wall or ceiling only as recommended by the manufacturer.
- 23 Heat – The product should be situated away from heat sources such as radiators, heat registers, stoves, or other products (including amplifiers) that produce heat.

- 24 Outdoor Antenna Grounding – If an outside antenna or cable system is connected to the product, be sure the antenna or cable system is grounded so as to provide some protection against voltage surges and built-up static charges. Article 810 of the National Electrical Code, ANSI/NFPA 70, provides information with regard to proper grounding of the mast and supporting structure, grounding of the lead-in wire to an antenna discharge unit, size of grounding conductors, location of antenna discharge unit, connection to grounding electrodes, and requirements for the grounding electrode.

EXAMPLE OF ANTENNA GROUNDING

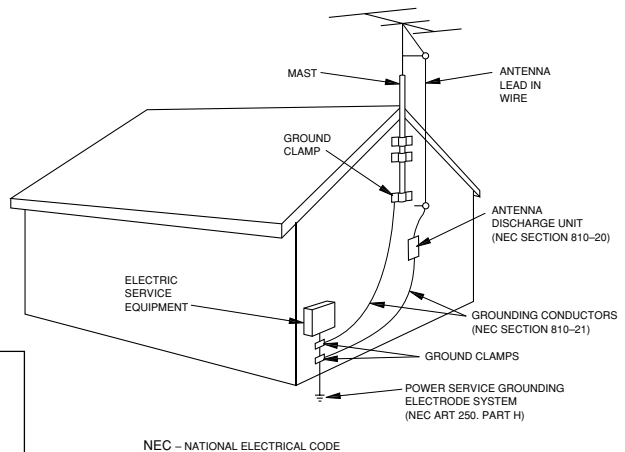

Note to CATV system installer:

This reminder is provided to call the CATV system installer's attention to Article 820-40 of the NEC that provides guidelines for proper grounding and, in particular, specifies that the cable ground shall be connected to the grounding system of the building, as close to the point of cable entry as practical.

FCC INFORMATION (for US customers)

1. **IMPORTANT NOTICE : DO NOT MODIFY THIS UNIT!**
This product, when installed as indicated in the instructions contained in this manual, meets FCC requirements. Modifications not expressly approved by Yamaha may void your authority, granted by the FCC, to use the product.
2. **IMPORTANT :** When connecting this product to accessories and/or another product use only high quality shielded cables. Cable/s supplied with this product **MUST** be used. Follow all installation instructions. Failure to follow instructions could void your FCC authorization to use this product in the USA.
3. **NOTE :** This product has been tested and found to comply with the requirements listed in FCC Regulations, Part 15 for Class "B" digital devices. Compliance with these requirements provides a reasonable level of assurance that your use of this product in a residential environment will not result in harmful interference with other electronic devices. This equipment generates/uses radio frequencies and, if not installed and used according to the instructions found in the users manual, may cause interference harmful to the operation of other electronic devices.

Compliance with FCC regulations does not guarantee that interference will not occur in all installations. If this product is found to be the source of interference, which can be determined by turning the unit "OFF" and "ON", please try to eliminate the problem by using one of the following measures:
Relocate either this product or the device that is being affected by the interference.
Utilize power outlets that are on different branch (circuit breaker or fuse) circuits or install AC line filter/s.
In the case of radio or TV interference, relocate/reorient the antenna. If the antenna lead-in is 300 ohm ribbon lead, change the lead-in to coaxial type cable.
If these corrective measures do not produce satisfactory results, please contact the local retailer authorized to distribute this type of product. If you can not locate the appropriate retailer, please contact Yamaha Electronics Corp., U.S.A. 6660 Orangethorpe Ave, Buena Park, CA 90620.
The above statements apply **ONLY** to those products distributed by Yamaha Corporation of America or its subsidiaries.

CAUTION: READ THIS BEFORE OPERATING YOUR UNIT.

- 1 To assure the finest performance, please read this manual carefully. Keep it in a safe place for future reference.
- 2 Install this sound system in a well ventilated, cool, dry, clean place — away from direct sunlight, heat sources, vibration, dust, moisture, and/or cold. Allow ventilation space of at least 30 cm on the top, 20 cm on the left and right, and 20 cm on the back of this unit.
- 3 Locate this unit away from other electrical appliances, motors, or transformers to avoid humming sounds.
- 4 Do not expose this unit to sudden temperature changes from cold to hot, and do not locate this unit in a environment with high humidity (i.e. a room with a humidifier) to prevent condensation inside this unit, which may cause an electrical shock, fire, damage to this unit, and/or personal injury.
- 5 Avoid installing this unit where foreign object may fall onto this unit and/or this unit may be exposed to liquid dripping or splashing. On the top of this unit, do not place:
 - Other components, as they may cause damage and/or discoloration on the surface of this unit.
 - Burning objects (i.e. candles), as they may cause fire, damage to this unit, and/or personal injury.
 - Containers with liquid in them, as they may fall and liquid may cause electrical shock to the user and/or damage to this unit.
- 6 Do not cover this unit with a newspaper, tablecloth, curtain, etc. in order not to obstruct heat radiation. If the temperature inside this unit rises, it may cause fire, damage to this unit, and/or personal injury.
- 7 Do not plug in this unit to a wall outlet until all connections are complete.
- 8 Do not operate this unit upside-down. It may overheat, possibly causing damage.
- 9 Do not use force on switches, knobs and/or cords.
- 10 When disconnecting the power cord from the wall outlet, grasp the plug; do not pull the cord.
- 11 Do not clean this unit with chemical solvents; this might damage the finish. Use a clean, dry cloth.
- 12 Only voltage specified on this unit must be used. Using this unit with a higher voltage than specified is dangerous and may cause fire, damage to this unit, and/or personal injury. YAMAHA will not be held responsible for any damage resulting from use of this unit with a voltage other than specified.
- 13 To prevent damage by lightning, disconnect the power cord from the wall outlet during an electrical storm.
- 14 Do not attempt to modify or fix this unit. Contact qualified YAMAHA service personnel when any service is needed. The cabinet should never be opened for any reasons.
- 15 When not planning to use this unit for long periods of time (i.e. vacation), disconnect the AC power plug from the wall outlet.
- 16 Be sure to read the “TROUBLESHOOTING” section on common operating errors before concluding that this unit is faulty.
- 17 Before moving this unit, press STANDBY/ON to set this unit in standby mode, and disconnect the AC power plug from the wall outlet.
- 18 **VOLTAGE SELECTOR (Asia and General models only)**
The VOLTAGE SELECTOR on the rear panel of this unit must be set for your local main voltage BEFORE plugging into the AC main supply. Voltages are 110V-120V, 220V-240V AC, 50/60 Hz.

This unit is not disconnected from the AC power source as long as it is connected to the wall outlet, even if this unit itself is turned off. This state is called standby mode. In this state, this unit is designed to consume a very small quantity of power.

WARNING

TO REDUCE THE RISK OF FIRE OR ELECTRIC SHOCK, DO NOT EXPOSE THIS UNIT TO RAIN OR MOISTURE.

IMPORTANT

Please record the serial number of this unit in the space below.

MODEL:

Serial No.:

The serial number is located on the rear of the unit.

Retain this Owner's Manual in a safe place for future reference.

FOR CANADIAN CUSTOMERS

To prevent electric shock, match wide blade of plug to wide slot and fully insert.

This Class B digital apparatus complies with Canadian ICES-003.

We Want You Listening For A Lifetime

YAMAHA and the Electronic Industries Association's Consumer Electronics Group want you to get the most out of your equipment by playing it at a safe level. One that lets the sound come through loud and clear without annoying blaring or distortion – and, most importantly, without affecting your sensitive hearing.

Since hearing damage from loud sounds is often undetectable until it is too late, YAMAHA and the Electronic Industries Association's Consumer Electronics Group recommend you to avoid prolonged exposure from excessive volume levels.



CONTENTS

INTRODUCTION

FEATURES	2
GETTING STARTED	3
Supplied accessories	3
Installing batteries in the remote control	3
CONTROLS AND FUNCTIONS	4
Front panel	4
Remote control	6
Front panel display	8

PREPARATION

CONNECTIONS	9
Before connecting components	9
Connecting video components	10
Connecting audio components	12
Connecting the antennas	13
Connecting an external decoder	14
Connecting the speakers	15
Connecting the power supply cord	18
Turning on the power	20
BASIC SYSTEM SETTINGS	21
Using the basic menu	21
Setting the unit to match your speaker system	23
SP LEVEL (Setting speaker output levels)	23

BASIC OPERATION

PLAYBACK	24
Input modes and indications	26
Selecting a sound field program	27
DIGITAL SOUND FIELD PROCESSING	
(DSP)	30
Understanding sound fields	30
HiFi DSP programs	30
CINEMA DSP	31
Sound design of CINEMA DSP	31
CINEMA DSP Programs	31
Sound field effects	33
TUNING	34
Presetting stations	35
Selecting preset stations	37
SLEEP TIMER	38
RECORDING	39

ADVANCED OPERATION

SET MENU	40
Set menu list	40
Adjusting the items on the set menu	40
SOUND 1 SPEAKER SET	
(speaker mode settings)	41
SOUND 2 SP DISTANCE (speaker distance)	43
SOUND 3 LFE LEVEL	43
SOUND 4 D. RANGE (dynamic range)	43
SOUND 5 CENTER GEQ	
(center graphic equalizer)	44
SOUND 6 HP TONE CTRL	
(headphone tone control)	44
INPUT 1 I/O ASSIGN	
(input/output assignment)	44
INPUT 2 INPUT MODE (initial input mode)	44
OPTION 1 DISPLAY SET	45
OPTION 2 MEM. GUARD (memory guard)	45
OPTION 3 AUDIO MUTE	45
ADVANCED SETUP MENU	46
REMOTE CONTROL FEATURES	47
Control area	47
Setting remote control codes	48
Controlling other components	49
SETTING THE SPEAKER LEVELS	50
Adjusting the speaker levels during playback	50
Using the test tone	50

ADDITIONAL INFORMATION

EDITING SOUND FIELD PARAMETERS	51
Changing parameter settings	51
Sound field parameter descriptions	52
TROUBLESHOOTING	53
RESETTING THE FACTORY PRESETS	57
GLOSSARY	58
SPECIFICATIONS	60

INTRODUCTION

PREPARATION

BASIC
OPERATION

ADVANCED
OPERATION

ADDITIONAL
INFORMATION

FEATURES

Built-in 5-channel power amplifier

- ◆ Minimum RMS output power
[U.S.A. and Canada models]
(0.9% THD, 1 kHz, 6 Ω/8 Ω)
Front: 110 W + 110 W
Center: 110 W
Surround: 110 W + 110 W

[Other models]

(0.9% THD, 1 kHz, 6 Ω)

- Front: 100 W + 100 W
Center: 100 W
Surround: 100 W + 100 W

Sound field features

- ◆ Dolby Pro Logic/Dolby Pro Logic II decoder
- ◆ Dolby Digital/Dolby Digital + Matrix 6.1 Decoder
- ◆ DTS/DTS + Matrix 6.1 Decoder
- ◆ CINEMA DSP: Combination of YAMAHA DSP technology and Dolby Pro Logic, Dolby Digital or DTS
- ◆ Virtual CINEMA DSP
- ◆ SILENT CINEMA™

Sophisticated AM/FM Tuner

- ◆ 40-Station random access preset tuning
- ◆ Automatic preset tuning
- ◆ Preset station shifting capability (Preset editing)

Other features

- ◆ 192 kHz/24-bit D/A converter
- ◆ Set menu for optimizing this unit for your Audio/Video system
- ◆ Test tone generator for easier speaker balance adjustment
- ◆ 6-channel external decoder input
- ◆ Optical and coaxial digital audio signal jacks
- ◆ Sleep timer
- ◆ Remote control with preset remote control codes

■ About this manual

-  indicates a tip for your operation.
- Some operations can be performed by using either the buttons on the main unit or on the remote control. In cases when the button names differ between the main unit and the remote control, the button name on the remote control is given in parentheses.
- This manual is printed prior to production. Design and specifications are subject to change in part for the reason of the improvement in operativity ability, and others. In this case, the product has priority.



Manufactured under license from Dolby Laboratories.

“Dolby”, “Pro Logic”, and the double-D symbol are trademarks of Dolby Laboratories.

SILENT™
CINEMA

“SILENT CINEMA” is a trademark of YAMAHA CORPORATION.



“DTS” and “DTS Digital Surround” are registered trademarks of Digital Theater Systems, Inc.

GETTING STARTED

Supplied accessories

Please check that you received all of the following parts.

Remote control

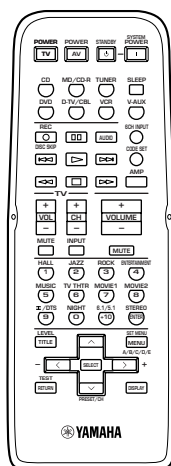

Batteries (2)
(AA, R06, UM-3)

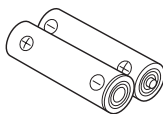

AM loop antenna

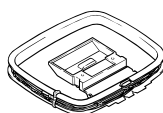

Indoor FM antenna
(U.S.A., Canada, China, Asia
and General models)

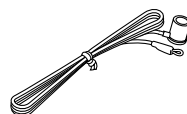

(Europe, U.K., Australia and
Korea models)

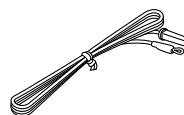

Installing batteries in the remote control

Insert the batteries in the correct direction by aligning the + and – marks on the batteries with the polarity markings (+ and –) inside the battery compartment.

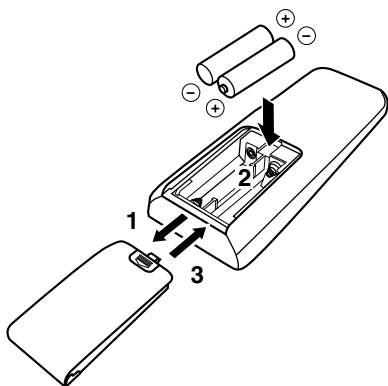

1 Press the part marked with a  and slide off the battery compartment cover.

2 Insert the two batteries supplied (AA, R06, UM-3) according to the polarity markings on the inside of the battery compartment.

3 Slide the cover back on so that it snaps into place.

Notes on batteries

- Change all of the batteries if you notice a decrease in the operating range of the remote control.
- Do not use old batteries together with new ones.
- Do not use different types of batteries (such as alkaline and manganese batteries) together. Read the packaging carefully as these different types of batteries may have the same shape and color.
- If the batteries have leaked, dispose of them immediately. Avoid touching the leaked material or letting it come into contact with clothing, etc. Clean the battery compartment thoroughly before installing new batteries.
- Do not throw away batteries with general house waste; dispose of them correctly in accordance with your local regulations.

If the remote control is without batteries for more than 2 minutes, or if exhausted batteries remain in the remote control, the contents of the memory may be cleared. When the memory is cleared, insert new batteries, set up the remote control code and program any acquired functions that may have been cleared.

CONTROLS AND FUNCTIONS

Front panel

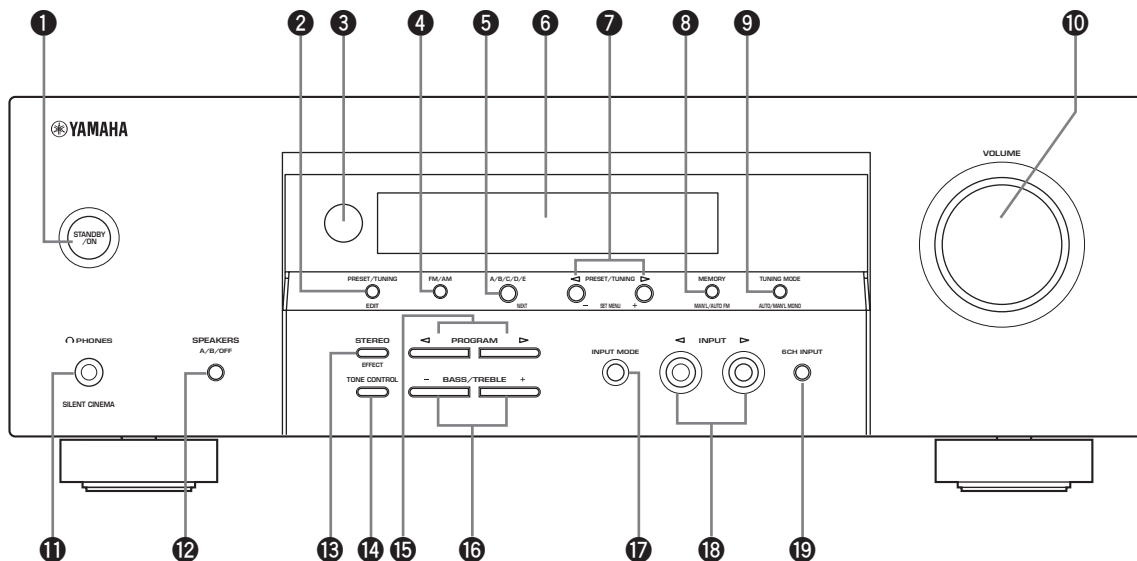

1 STANDBY/ON

Turns on this unit or sets it to the standby mode. When you turn on this unit, you will hear a click and there will be a 4 to 5-second delay before this unit can reproduce sound.

Note

In standby mode, this unit consumes a small amount of power in order to receive infrared-signals from the remote control.

2 PRESET/TUNING

Switches the function of PRESET/TUNING $\triangleleft/\triangleright$ between selecting a preset station number and tuning (the colon (:) turns on or off).

(EDIT)

This button is also used to exchange the assignment of two preset stations with each other.

3 Remote control sensor

Receives signals from the remote control.

4 FM/AM

Switches the reception band between FM and AM.

5 A/B/C/D/E

Selects preset station groups A to E when the unit is in tuner mode.

(NEXT)

Selects the set menu mode when the unit is not in tuner mode.

6 Front panel display

Shows information about the operational status of the unit.

7 PRESET/TUNING $\triangleleft/\triangleright$

Select preset station numbers 1 to 8 when a colon (:) is displayed in the front panel display.

Select the tuning frequency when a colon (:) is not displayed in tuner mode.

(SET MENU -/+)

Adjust settings on the set menu when the unit is not in tuner mode.

8 MEMORY (MAN'L/AUTO FM)

Stores a station in the memory.

9 TUNING MODE (AUTO/MAN'L MONO)

Switches the tuning mode between automatic and manual.

10 VOLUME

Controls the output level of all audio channels.
This does not affect the OUT (REC) level.

11  PHONES (SILENT CINEMA)

Allows you to enjoy DSP effects when listening with headphones.

12 SPEAKERS A/B/OFF

Selects the set of front speakers connected to the A or B terminals. To turn off the speakers, press the button repeatedly and select OFF.

13 STEREO (EFFECT)

Switches between normal stereo and DSP effect reproduction. When you select STEREO, the unit mixes down all Dolby Digital and DTS signals (except the LFE channel) as well as those 2-channel signals without effect sounds to the front left and right speakers.

14 TONE CONTROL

Switches between Bass (low-frequency response) control mode and Treble (high-frequency response) control mode.

15 PROGRAM  / 

Use to select sound field programs.

16 BASS/TREBLE  / 

Increase or decrease low/high-frequency response when the unit is in Bass/Treble control mode. The sound changes 2dB each time you press one of these buttons. Control range: -10 to +10dB.

17 INPUT MODE

Sets the priority for the types of input signals (AUTO, DTS, ANALOG) received when one component is connected to two types of input jacks. You cannot set priority for an audio sources if you have selected 6CH INPUT as the input source.

18 INPUT  / 

Selects the input source you want to listen to or watch.

19 6CH INPUT

Selects the audio source connected to the 6CH INPUT jacks. This selection takes priority over sources selected with INPUT (or the input selector buttons on the remote control).

Remote control

This section describes the controls and functions of the remote control when it is set in AMP mode. Please make sure to select AMP mode before beginning operation. See "REMOTE CONTROL FEATURES" on page 47 to operate other components with this remote control.

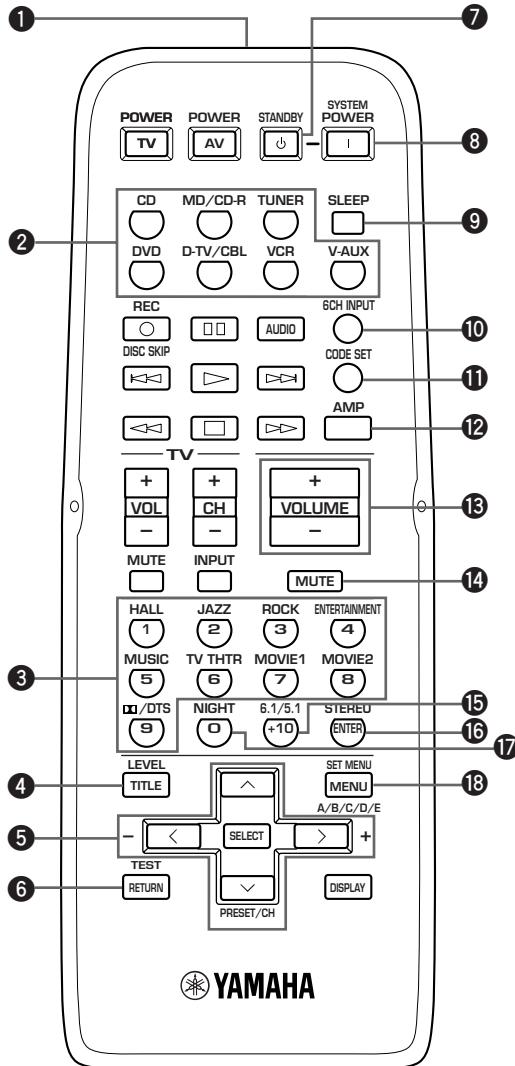

1 Infrared emitter

Outputs infrared control signals. Aim this emitter at the component you want to operate.

2 Input selector buttons

Select the input source and change the control area.

3 Sound field program/Numeric buttons

Use to select sound field programs or input numbers.

4 LEVEL

Selects the effect speaker channel to adjust.

5 Cursor buttons \wedge / \vee / \langle / \rangle / SELECT

Use to select and adjust sound field program parameters or SET MENU items.

6 TEST

Outputs the test tone to adjust the speaker levels.

7 STANDBY

Sets this unit in standby mode.

8 SYSTEM POWER

Turns on the power of the unit.

9 SLEEP

Sets the sleep timer.

10 6CH INPUT

Selects the audio source connected to the 6CH INPUT jacks.

11 CODE SET

Use to set up remote control codes (see page 48).

12 AMP

Switches control from a previously selected component by using the input selector buttons to this unit.

13 VOLUME +/-

Increases or decreases the volume level.

14 MUTE

Mutes the sound. Press again to restore the audio output to the previous volume level.

15 6.1/5.1

Switches on or off the Dolby Digital + Matrix 6.1 or DTS + Matrix 6.1 decoder.

16 STEREO

Switches between normal stereo and DSP effect reproduction. When you select STEREO the unit mixes down all Dolby Digital and DTS signals (except the LFE channel) as well as those 2-channel signals without effect sounds, to the front left and right speakers.

17 NIGHT

Sets the unit in night listening mode.

18 SET MENU

Selects the set menu mode.

■ Using the remote control

The remote control transmits a directional infrared beam. Be sure to aim the remote control directly at the remote control sensor on the main unit during operation.

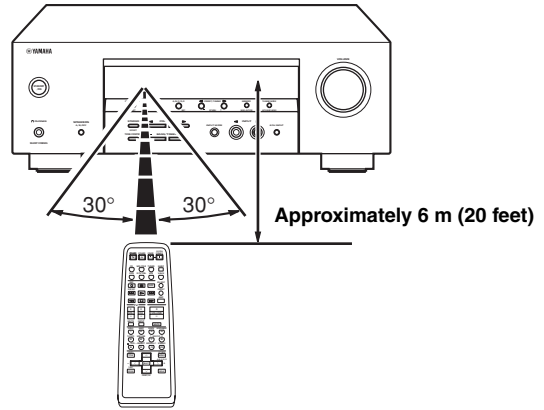
**■ Handling the remote control**

- Do not spill water or other liquids on the remote control.
- Do not drop the remote control.
- Do not leave or store the remote control in the following types of conditions:
 - high humidity such as near a bath
 - high temperature such as near a heater or stove
 - extremely low temperature
 - dusty places

Front panel display

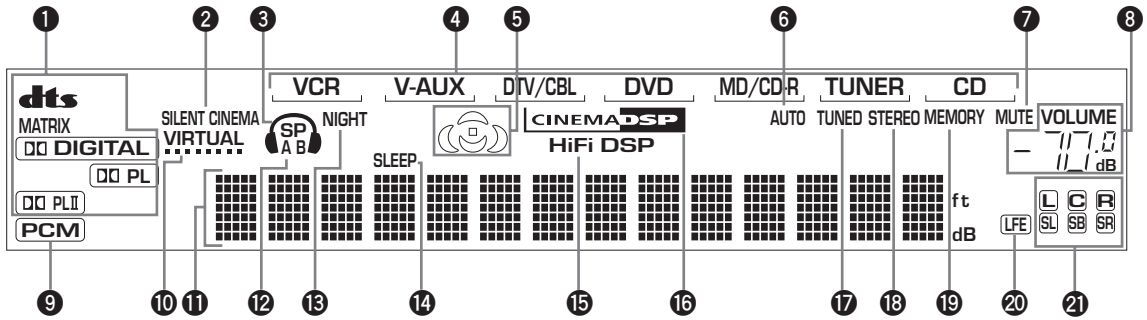

1 Decoder indicators

When any of this unit's decoders function, the respective indicator lights up.

2 SILENT CINEMA indicator

Lights up when headphones are connected and a sound field program is selected (see page 27).

3 Headphones indicator

Lights up when headphones are connected to the headphone jack.

4 Input source indicator

Highlights the current input source with a cursor.

5 Sound field indicator

Light to indicate the active DSP sound fields.

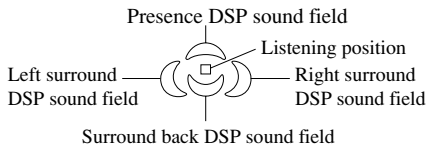

6 AUTO indicator

Shows that this unit is in the automatic tuning mode.

7 MUTE indicator

Flashes while the MUTE function is on.

8 VOLUME level indicator

Indicates the volume level.

9 PCM indicator

Lights up when this unit is reproducing PCM (pulse code modulation) digital audio signals.

10 VIRTUAL indicator

Lights up when using Virtual CINEMA DSP.

11 Multi-information display

Shows the current sound field program name and other information when adjusting or changing settings.

12 SP A B indicator

Lights up to indicate which set of front speakers is selected.

13 NIGHT indicator

Lights up when the unit is set to night listening mode.

14 SLEEP indicator

Lights up while the sleep timer is on.

15 HiFi DSP indicator

Lights up when you select a HiFi DSP sound field program.

16 CINEMA DSP indicator

Lights up when you select a CINEMA DSP sound field program.

17 TUNED indicator

Lights up when this unit is tuned to a radio station.

18 STEREO indicator

Lights up when the unit is receiving a strong signal from a FM stereo broadcast while the "AUTO" indicator is lit.

19 MEMORY indicator

Flashes to show a station can be stored.

20 LFE indicator

Lights up when the input signal contains an LFE signal.

21 Input channel indicator

The indicators for the appropriate sound channels light up when a digital signal from a source is played back.

CONNECTIONS

Before connecting components

CAUTION

Do not connect this unit or other components to the mains power until all connections between the components have been completed.

- Be sure to connect the left channel (L), right channel (R), “+” (red) and “-” (black) properly. Some components require different connection methods and have different jack names. Refer to the operation instructions for each component you wish to connect to this unit.
- After you have completed all connections, check them again to make sure they are correct.
- The jack names correspond to the names on the input selector.

Connecting to digital jacks

This unit has digital jacks for direct transmission of digital signals through either a coaxial or fiber optic cable. You can use the digital jacks to input PCM, Dolby Digital and DTS bitstreams. Use digital connections if you wish to enjoy the multi-channel sound track of DVD material, etc. with DSP effects. Both digital input jacks are acceptable for 96 kHz sampling digital signals.

Note

- The OPTICAL jack on this unit conform to the EIA standard. If you use a fiber optic cable that does not conform to EIA standard, this unit may not function properly.

Signal flow inside this unit

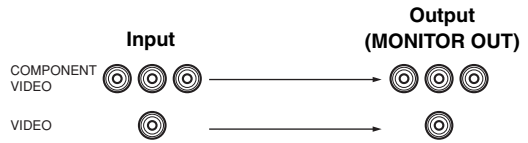

DIGITAL INPUT jacks (pages 9 – 12)

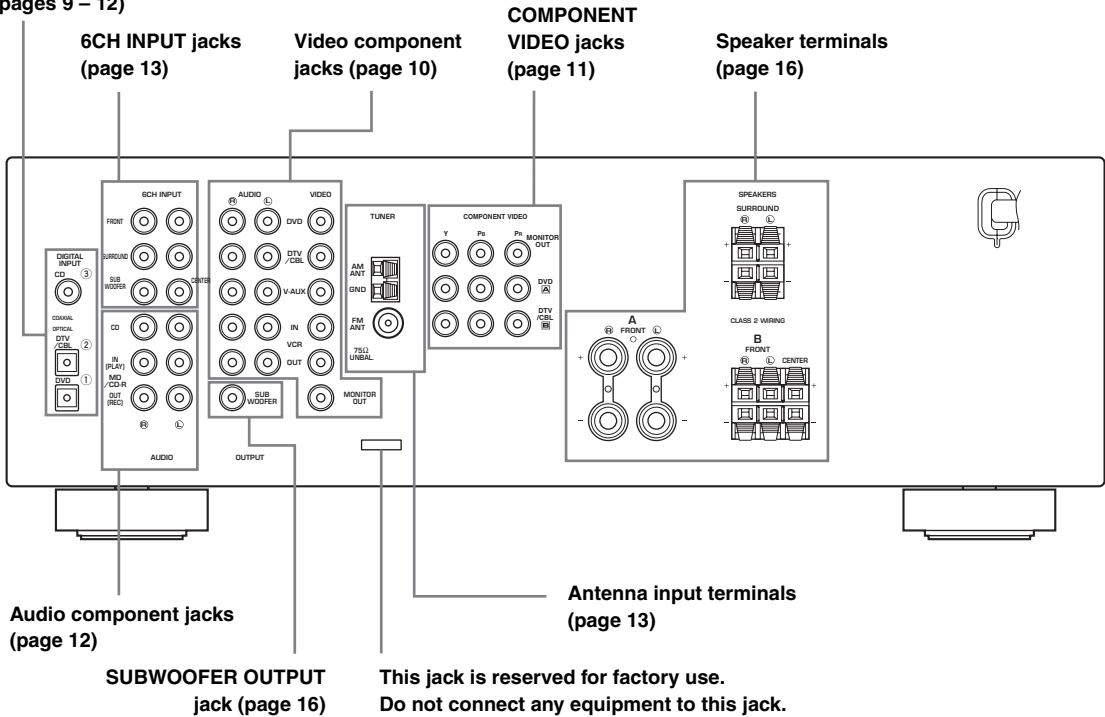

Connecting video components

■ Connecting a video monitor

Connect the video input jack on your video monitor to the MONITOR OUT VIDEO jack.

■ Connecting a DVD player/digital TV/cable TV

Connect the optical digital audio signal output jack on your component to the DIGITAL INPUT jack and connect the video signal output jack on the component to the VIDEO jack on this unit.



- Use the AUDIO jacks on this unit for a video component which does not have optical digital output jack. However, multi-channel reproduction cannot be obtained with audio signals input from the AUDIO jacks. If you wish to enjoy the surround sound, use DD/DTS on the remote control (see page 28).
- You can also connect a video monitor, DVD player, digital TV, and cable TV to this unit using the COMPONENT VIDEO connections (see page 11).

■ Connecting another video component

Connect the video signal output jack on your component to the VIDEO jack on this unit.

Connect the audio signal output jacks on the component to the AUDIO jacks on this unit.

■ Connecting a recording component

Connect the audio signal input jacks on your video component to the AUDIO OUT jacks on this unit. Then connect the video signal input jack on the video component to the VIDEO OUT jack on this unit for picture recording.

Connect the audio signal output jacks on your component to the AUDIO IN jacks on this unit. Then connect the video signal output jack on the component to the VIDEO IN jack on this unit to play a source from your recording component.

Notes

- Once you have connected a recording component to this unit, keep its power turned on while using this unit. If the power is off, this unit may distort the sound from other components.
- If you connect your video monitor to this unit using a VIDEO connection, connect your video source components such as a DVD player or digital TV to this unit using the VIDEO connections.

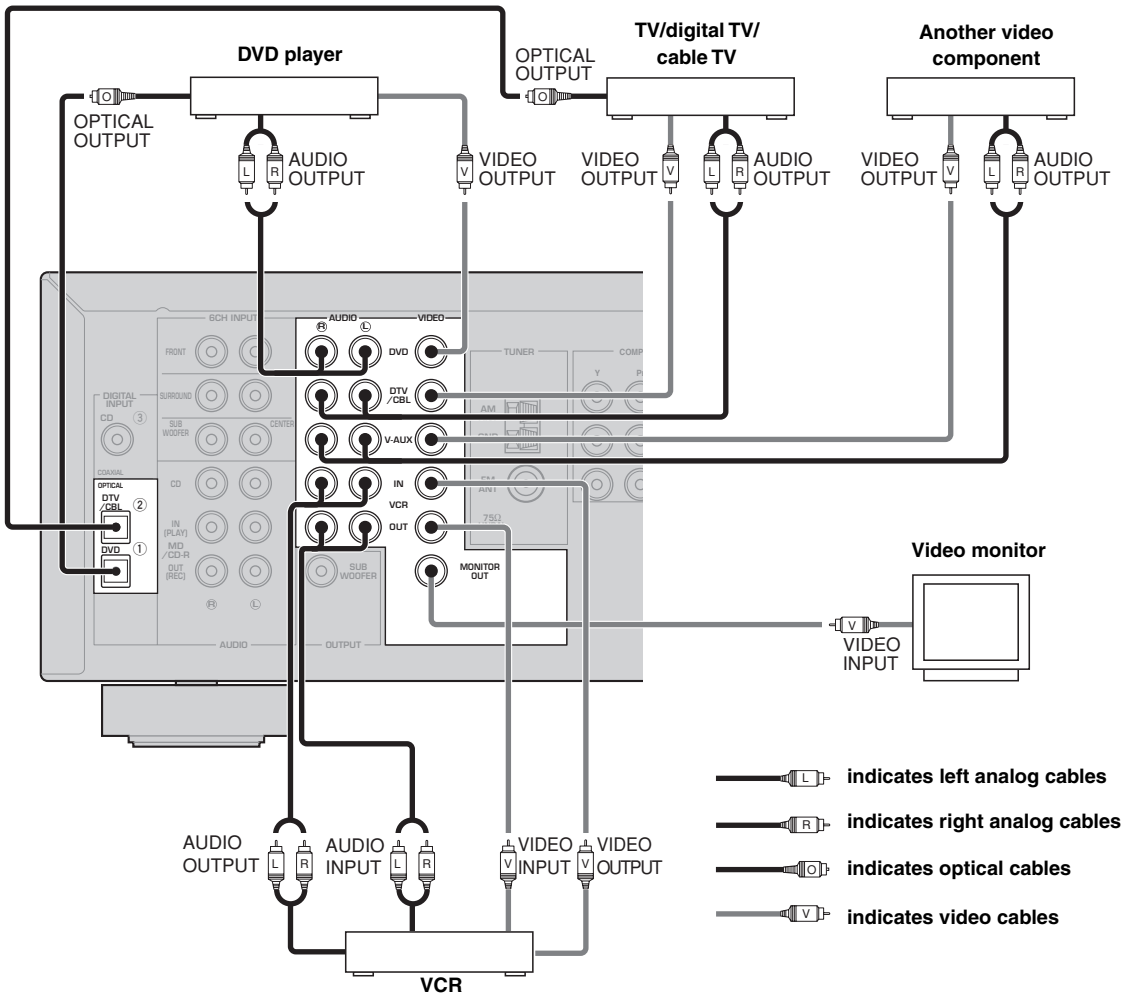

■ COMPONENT VIDEO jacks

You can enjoy high-quality pictures by connecting your video monitor and video source components to this unit using COMPONENT VIDEO connections.

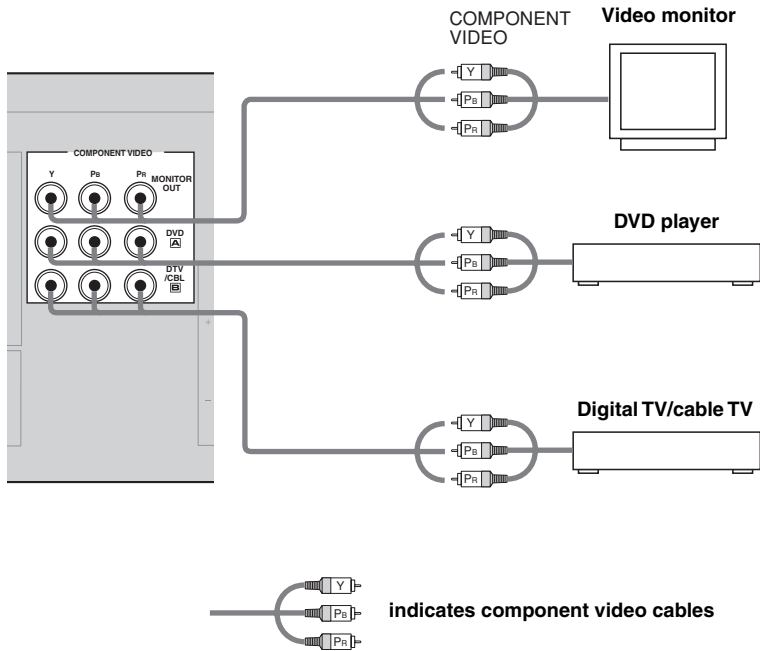

Note

- If you connect your video monitor to this unit using a COMPONENT VIDEO connection, connect your video source components such as a DVD player or digital TV to this unit using the VIDEO COMPONENT connections.

Connecting audio components

■ Connecting a CD player

Connect the coaxial digital output jack on your CD player to the DIGITAL INPUT CD jack on this unit.



- Use the AUDIO jacks on this unit to connect to a CD player that does not have a COAXIAL DIGITAL OUTPUT jack, or to record from CD players.

■ Connecting a CD recorder or MD recorder

Connect the input jacks on your CD recorder or MD recorder to the MD/CD-R OUT (REC) jacks.

Connect the output jacks on your CD recorder or MD recorder to the MD/CD-R IN (PLAY) jacks to play a source from your recording component.

Note

- Once you have connected a recording component to this unit, keep its power turned on while using this unit. If the power is off, this unit may distort the sound from other components.

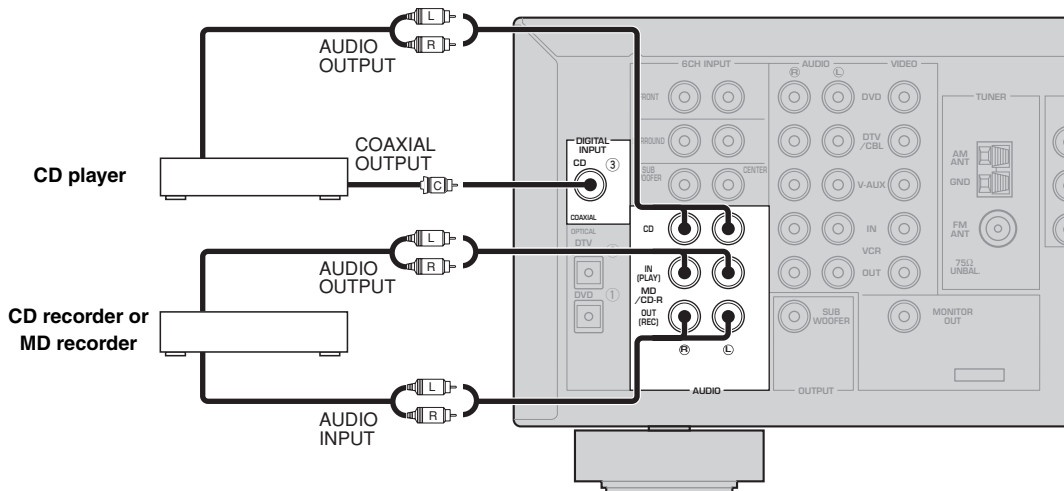

- indicates left analog cables
- indicates right analog cables
- indicates coaxial cables

Connecting the antennas

Both AM and FM indoor antennas are included with this unit. In general, these antennas should provide sufficient signal strength.

Connect each antenna correctly to the designated terminals.

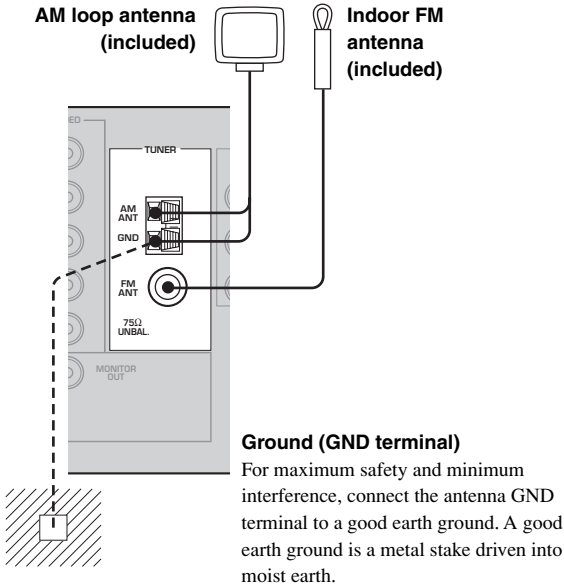

■ Connecting the AM loop antenna

- 1 Set up the AM loop antenna, then connect it to the terminals on this unit.

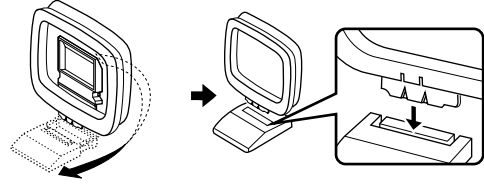

- 2 Press and hold the tab to insert the AM loop antenna lead wires into the AM ANT and GND terminals.

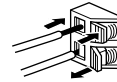

- 3 Orient the AM loop antenna for the best reception.

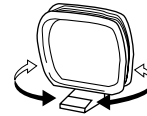

Notes

- The AM loop antenna should be placed away from this unit.
- The AM loop antenna should always be connected, even if an outdoor AM antenna is connected to this unit.
- A properly installed outdoor antenna provides clearer reception than an indoor one. If you experience poor reception quality, an outdoor antenna may improve the quality. Consult the nearest authorized YAMAHA dealer or service center about the outdoor antennas.

Connecting an external decoder

This unit is equipped with 6 additional input jacks (FRONT left and right, CENTER, SURROUND left and right and SUBWOOFER) for discrete multi-channel input from a component equipped with a multi-channel decoder and 6 channel output jacks such as a DVD/Super Audio CD player.

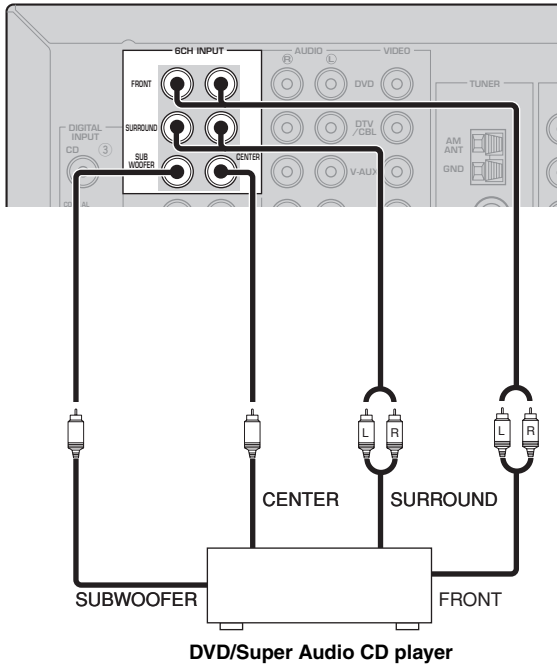

Notes

- When you select 6CH INPUT as the input source, this unit automatically turns off the digital sound field processor, and you cannot select sound field programs.
- When headphones are used, only front L/R channels are output.

Connecting the speakers

■ Speaker placement

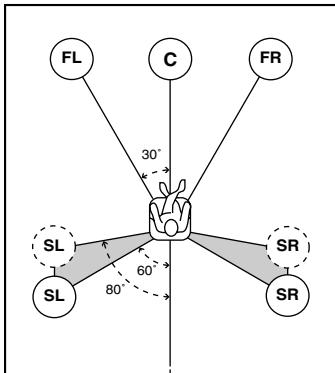

The speaker layout above shows the standard ITU-R speaker setting. You can use it to enjoy CINEMA DSP, multi-channel audio sources.

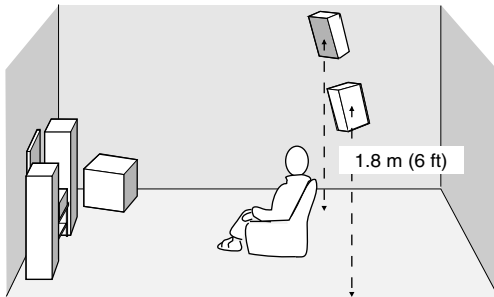

Front speakers (FR and FL)

The front speakers are used for the main source sound plus effect sounds. Place these speakers an equal distance from the ideal listening position. The distance of each speaker from each side of the video monitor should be the same.

Center speaker (C)

The center speaker is for the center channel sounds (dialog, vocals, etc.). If for some reason it is not practical to use a center speaker, you can do without it. Best results, however, are obtained with the full system. Align the front face of the center speaker with the front face of your video monitor. Place the speaker centrally between the front speakers and as close to the monitor as possible, such as directly over or under it.

Surround speakers (SR and SL)

The surround speakers are used for effect and surround sounds. Place these speakers behind your listening position, facing slightly inwards, about 1.8 m (6 ft) above the floor.

Subwoofer

The use of a subwoofer, such as the YAMAHA Active Servo Processing Subwoofer System, is effective not only for reinforcing bass frequencies from any or all channels, but also for high fidelity reproduction of the LFE (low - frequency effect) channel included in Dolby Digital and DTS software. The position of the subwoofer is not so critical, because low bass sounds are not highly directional. But it is better to place the subwoofer near the front speakers. Turn it slightly toward the center of the room to reduce wall reflections.

■ Speaker connections

Be sure to connect the left channel (L), right channel (R), “+” (red) and “-” (black) properly. If the connections are faulty, no sound will be heard from the speakers, and if the polarity of the speaker connections is incorrect, the sound will be unnatural and lack bass.

CAUTION

- Use speakers with the specified impedance shown on the rear panel of this unit.
- Before connecting the speakers, make sure that the power of this unit is off.
- Do not let the bare speaker wires touch each other or do not let them touch any metal part of this unit. This could damage this unit and/or speakers.
- Use magnetically shielded speakers. If this type of speakers still creates the interference with the monitor, place the speakers away from the monitor.

Connecting to the FRONT A SPEAKERS terminals

A speaker cord is actually a pair of insulated cables running side by side. One cable is colored or shaped differently, perhaps with a stripe, groove or ridges. Connect the striped (grooved, etc.) cable to the “+” (red) terminals on this unit and your speaker. Connect the plain cable to the “-” (black) terminals.

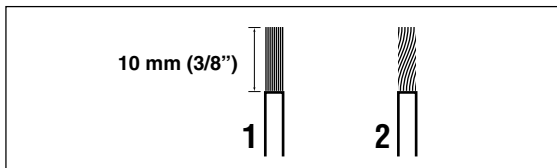

1 Remove approximately 10 mm (3/8") of insulation from the end of each of the speaker cables.

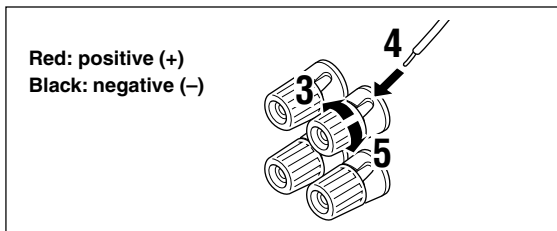

2 Twist the exposed wires of the cable together to prevent short circuits.

3 Loosen the head of the screw.

4 Insert one bare wire into the hole in the side of each terminal.

5 Tighten the head of the screw to secure the wire.

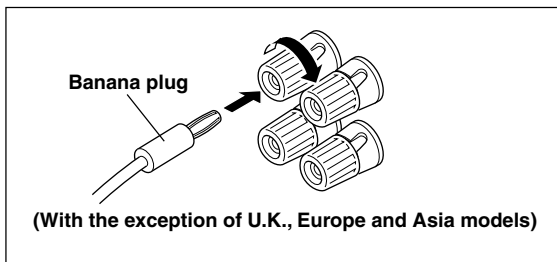

Banana plug connections

(With the exception of U.K., Europe and Asia models) First, tighten the knob and then insert the banana plug connector into the end of the corresponding terminal.

Connecting to the FRONT B, CENTER and SURROUND SPEAKERS terminals

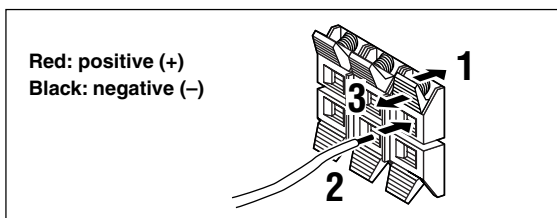

1 Press and open the tab.

2 Insert one bare wire into the hole of each terminal.

3 Release the tab to secure the wire.

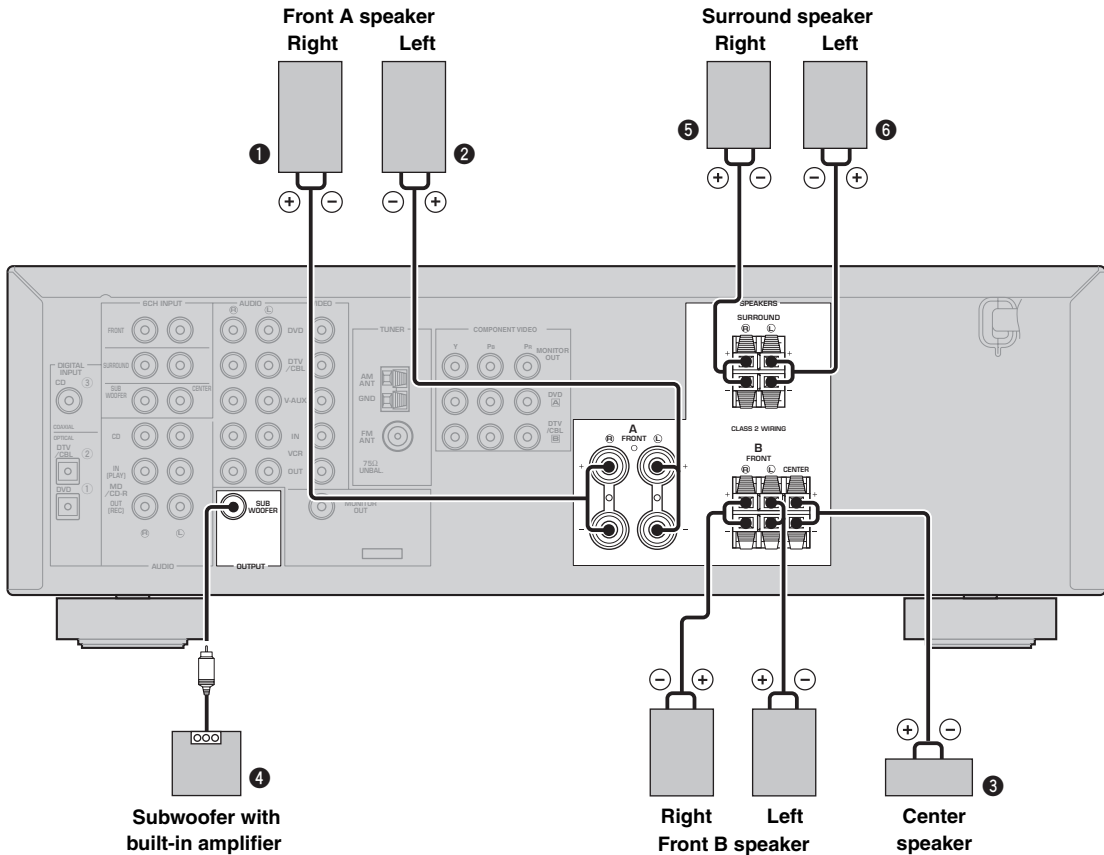

PREPARATION

FRONT SPEAKERS terminals

You can connect up to two speaker systems to these terminals. When using only one speaker system, connect it to either of the FRONT A or the FRONT B terminals.

SURROUND SPEAKERS terminals

A surround speaker system can be connected to these terminals.

CENTER SPEAKER terminals

A center speaker can be connected to these terminals.

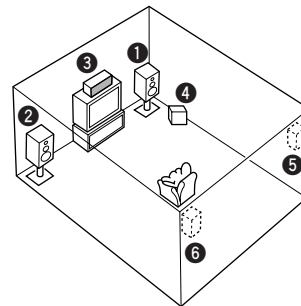

The diagram shows the speaker layout in the listening room.

SUBWOOFER jack

When using a subwoofer with built-in amplifier, including the YAMAHA Active Servo Processing Subwoofer System, connect the input jack of the subwoofer system to this jack. This unit will direct low bass signals distributed from the front, center and/or surround channels to this jack in accordance with your SPEAKER SET selections. The LFE (low-frequency effect) signals generated when Dolby Digital or DTS is decoded are also directed to this jack in accordance with your SPEAKER SET selections.

Notes

- The cut-off frequency of the SUBWOOFER jack is 90 Hz.
- If you do not use a subwoofer, allocate the signals to the front left and right speakers by changing the setting of "SOUND 1 SPEAKER SET" item "1D BASS" on the set menu to FRONT.
- Use the control on the subwoofer to adjust its volume level. You can also adjust the volume level by using this unit's remote control (see "SETTING THE SPEAKER LEVELS" on page 50).

Connecting the power supply cord

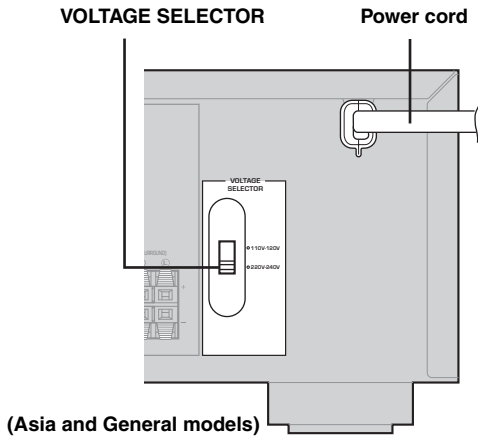

■ Connecting the AC power cord

Plug the power cord into an AC wall outlet.

■ VOLTAGE SELECTOR (Asia and General models only)

The VOLTAGE SELECTOR on the rear panel of this unit must be set for your local main voltage BEFORE plugging into the AC main supply. Voltages are: 110 V - 120 V/220 V - 240 V AC, 50/60 Hz.

**■ IMPEDANCE SELECTOR switch
(U.S.A. and Canada models only)**

CAUTION

Do not change the setting of the IMPEDANCE SELECTOR switch when the unit power is switched on, as doing so may damage the unit.

If this unit fails to turn on when STANDBY/ON is pressed on either the front panel or remote control, the IMPEDANCE SELECTOR switch may not be fully slid to either position. If this is the case, slide the switch all the way to either position when this unit is in standby mode.

Select the switch position (upper or lower) according to the impedance of the speakers in your system.

(U.S.A. model)

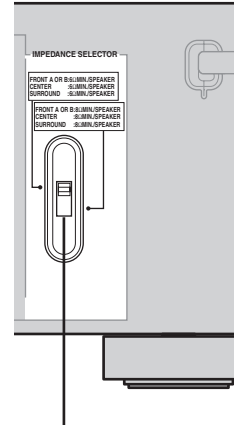

IMPEDANCE SELECTOR switch

PREPARATION

Switch position	Speaker	Impedance level
Upper	FRONT A OR B	The impedance of each speaker must be 6 Ω or higher.
	CENTER, SURROUND	The impedance of each speaker must be 6 Ω or higher.
Lower	FRONT A OR B	The impedance of each speaker must be 8 Ω or higher.
	CENTER, SURROUND	The impedance of each speaker must be 8 Ω or higher.

Turning on the power

When all connections are complete, turn on the power of this unit.

1

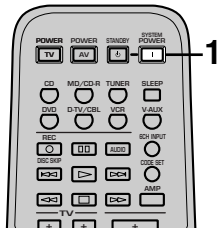
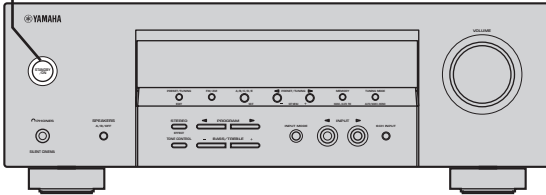

- 1 Press **STANDBY/ON** (or **SYSTEM POWER** on the remote control) to turn on the power of this unit.



Front panel

or



Remote control

The level of the volume, and then the current sound field program name appear on the front panel display.

BASIC SYSTEM SETTINGS

The “BASIC” menu allows you to set some of the basic “SOUND” menu parameters with a minimum of effort. If you wish to configure the unit more precisely to suit your listening environment, use the more detailed parameters from the “SOUND” menu instead of those under the “BASIC” menu (see page 40). Altering any parameters in the BASIC menu will reset all parameters in the “SOUND” menu.

Using the basic menu

Use the remote control to make adjustments.

- Press SPEAKERS A/B/OFF on the front panel to select the front speakers you want to use.
- Make sure you disconnect headphones from this unit.

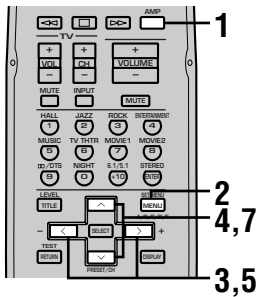

1 Press AMP.



2 Press SET MENU.

“BASIC MENU” appears on the front panel display.



If the front panel display changes to show anything other than “BASIC MENU”, press SET MENU until it displays “BASIC MENU”.

3 Press </> to enter into the BASIC menu.

“1 SETUP” appears on the front panel display.

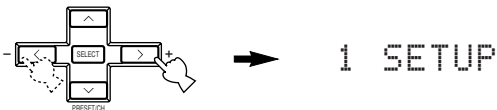

4 Press ^ / v to change the display to the setting you want to alter.

1 SETUP

Changes the speaker and amplifier settings to suit the size of the room you are using. Refer to “Setting the unit to match your speaker system” on page 23 for more information.

2 SP LEVEL

Adjusts the output levels of the speakers. Refer to “SP LEVEL” on page 23 for more information.

5 Press </> to enter the desired setting mode.

6 Change the unit settings to suit your listening environment.

7 Press ^ / v to exit from the set menu.

The front panel display changes in the following order:

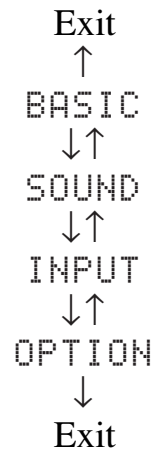
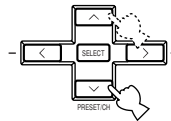

■ **Basic menu operation sequence**

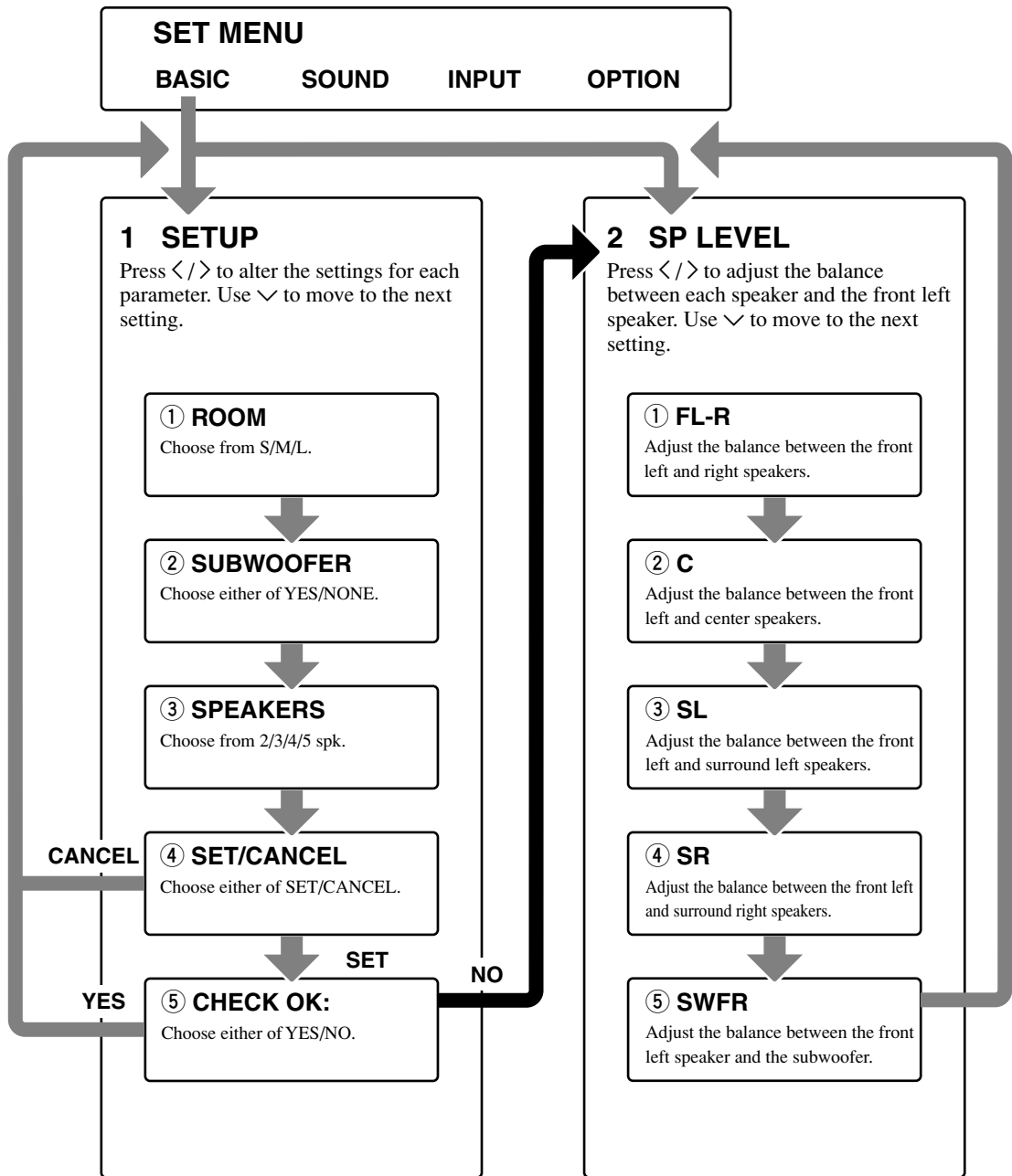

- After altering the “1 SETUP” parameters, readjust the output levels of the speakers at “2 SP LEVEL”.
- See pages 40 – 45 for a detailed explanation of the “SOUND”, “INPUT” and “OPTION” menus.

Setting the unit to match your speaker system

Follow the instructions below to set the amplifier output to match the size of your room and speakers. Press \wedge / \vee to cycle through parameters 1 through 4, and \langle / \rangle to alter the parameter setting.

Factory default settings are highlighted.

① ROOM

Settings: **S**, **M**, **L**

Select the size of the room you have installed your speakers in. Roughly speaking, the room sizes are defined as follows:

[U.S.A. and Canada models]

S: 16 x 13 ft, 200 ft² (4.8 x 4.0 m, 20 m²)

M: 20 x 16 ft, 300 ft² (6.3 x 5.0 m, 30 m²)

L: 26 x 19 ft, 450 ft² (7.9 x 5.8 m, 45 m²)

[Other models]

S: 3.6 x 2.8 m, 10 m²

M: 4.8 x 4.0 m, 20 m²

L: 6.3 x 5.0 m, 30 m²

② SUBWOOFER

Settings: **YES**, **NONE**

Select **YES** if you have a subwoofer in your system, or **NONE** if you do not.

③ SPEAKERS

Settings: 2, 3, 4, **5** (spk)

Select the number of speakers connected in your speaker configuration. This number does not include your subwoofer.

Setting	Display	Speaker
2spk	L R	Front L/R
3spk	L C R	Front L/R, Center
4spk	L R SL SR	Front L/R, Surround L/R
5spk	L C R SL SR	Front L/R, Center, Surround L/R

④ SET or CANCEL

Select **SET** to confirm the changes you made. Select **CANCEL** to exit **SETUP MENU** without altering any of the unit settings. The unit will output a test tone to the speakers (see ⑤).

⑤ Use the test tone to check the speaker levels.

When you select **SET** in ④, the display changes to “CHECK : Test Tone” for a few seconds, and the unit outputs a test tone to each of the speakers in turn twice. When the test tone begins, the display changes to “CHECK OK?--YES”.

If the test tone is output at the same volume from all of the speakers, select “CHECK OK: YES”. Press \vee to exit from the **SETUP** menu.

If the volume of the test tone varies between speakers, press \langle / \rangle to change the display to “NO”.

Note

- The indicator of the speaker currently outputting the test tone flashes on the front panel display.

SP LEVEL

(Setting speaker output levels)

Use this menu to compare and adjust the test tone output from each speaker to the output from the front left (or surround left) speaker so that the volume level for all speakers is identical. Press \wedge / \vee to select a speaker, then adjust the balance using \langle / \rangle .

Note

- The unit outputs the test tone from the selected speaker and the front left (or surround left) speaker in turn. The indicator of the speaker currently outputting the test tone flashes on the front panel display.

① L-R

Adjust the balance between the front left and right speakers.

② C

Adjust the balance between the front left and center speakers.

③ SL

Adjust the balance between the front left and surround left speakers.

④ SR

Adjust the balance between the surround left and surround right speakers.

⑤ SWFR

Adjust the balance between the front left speaker and the subwoofer.



- You can also balance the speaker levels using test tone by pressing **TEST** on the remote control.

PLAYBACK

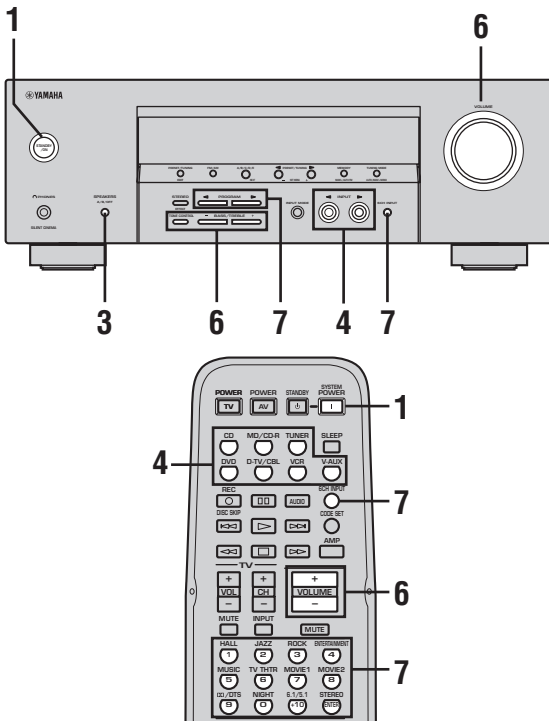

- 1 Press STANDBY/ON (or SYSTEM POWER on the remote control) to turn on the power.**

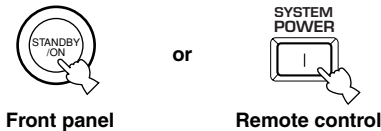

- 2 Turn on the video monitor connected to this unit.**

- 3 Press SPEAKERS A/B/OFF on the front panel to select the front speakers you want to use.**



- 4 Press INPUT </> repeatedly (or one of the input selector buttons on the remote control) to select the input you desire.**

The selected input source name and input mode appear on the front panel display for a few seconds.

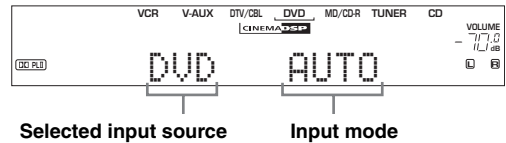
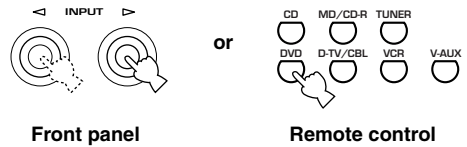

- 5 Start playback or select a broadcast station on the source component.**

Refer to the operation instructions for the component.

- 6 Adjust the volume to the desired level.**

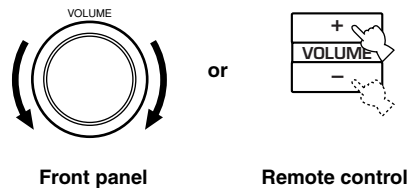

If desired, use TONE CONTROL and BASS/TREBLE +/- . These controls only effect the sound from the front speakers.

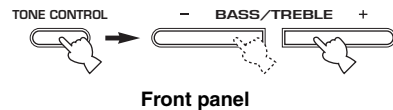

Notes

- If you increase or decrease the high-frequency or the low-frequency sound to an extreme level, the tonal quality from the center and surround speakers may not match that of the front left and right speakers.
- If you have connected a recording component to the VCR OUT, or MD/CD-R OUT jacks, and you notice distortion or low volume during playback from other components, try turning on the recording component.

- 7 Select a sound field program if desired.**
Press PROGRAM ◀/▶ (or press AMP to select the AMP mode, then press one of the field program buttons repeatedly on the remote control).
See pages 30 - 37 for details about sound field programs.

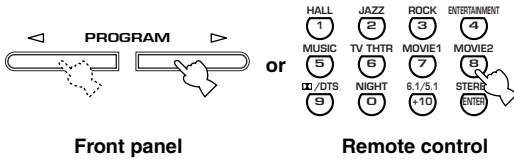

■ Selecting the 6CH INPUT

Press 6CH INPUT until “6CH INPUT” appears on the front panel display.

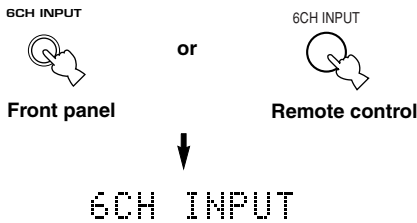

Note

- If “6CH INPUT” is shown on the front panel display, no other source can be played. To select another input source, first press 6CH INPUT so that “6CH INPUT” disappears from the front panel display.

■ Playing video sources in the background

You can combine a video image from a video source with a sound from an audio source. For example, you can enjoy listening to classical music while having beautiful scenery from the video source on the video monitor.

Use the input selector buttons to select a video source, then select an audio source.

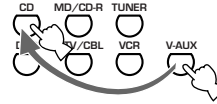

■ To mute the sound

Press MUTE on the remote control.

“MUTE” blinks on the front panel display.

To resume audio output, press MUTE again.



- You can also cancel mute by pressing VOLUME +/-, etc.
- You can adjust the muting level (see page 45).

■ Night listening mode

This mode reproduces dialogue clearly while reducing the volume of loud sound effects for easier listening at low volumes or at night.

Press NIGHT on the remote control.

The NIGHT indicator in the front panel display lights up.

Press NIGHT once more to return to normal reproduction.



- You can use night listening mode with any of the sound field programs.
- Night listening mode may vary in effectiveness depending on the input source and surround sound settings you use.

■ When you have finished using this unit

Press STANDBY/ON (STANDBY on the remote control) to set this unit in standby mode.



Front panel

or



Remote control

Input modes and indications

This unit is equipped with 2 types of input jacks. Do the following to select the type of input signals you want to use.

Press INPUT MODE repeatedly until the desired input mode is shown on the front panel display.

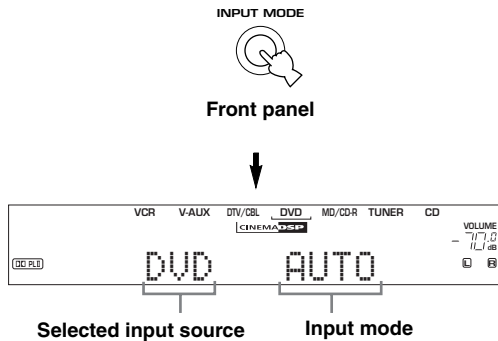

- AUTO** Automatically selects input signals in the following order:
 1) Digital signals*
 2) Analog signals
- DTS** Selects only digital signals encoded in DTS. If no DTS signals are input, no sound is output.
- ANALOG** Selects only analog signals. If no analog signals are input, no sound is output.

* If this unit detects a Dolby Digital or DTS signal, the decoder automatically switches to the appropriate sound field program.



You can adjust the default input mode on this unit (see page 44).

Notes

- When you play DTS encoded CD/LDs with the input mode set to AUTO:
 - This unit automatically switches to the DTS decoding mode. The unit remains in DTS mode (and the “**dts**” indicator may flash) for up to 30 second after playback of the DTS source is complete. To manually release the DTS mode, press INPUT MODE to reselect AUTO.
 - The DTS decoding mode may be released if search or skip operations are performed for more than 30 seconds. To prevent this, press INPUT MODE to select DTS.
- If the digital output data of the player has been processed in any way, you may not be able to perform DTS decoding even if you make a digital connection between this unit and the player.

Selecting a sound field program

You can enhance your listening experience by selecting sound field programs. For details about each program, see pages 30 – 33.

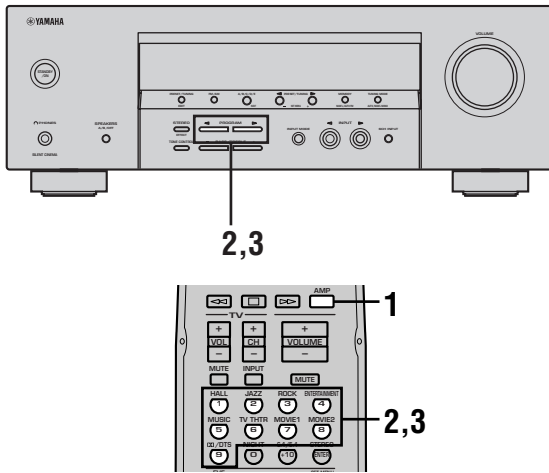

1 Press AMP.



2 Press one of the sound field program buttons on the remote control to select the desired program.

The name of the selected program appears on the front panel display.

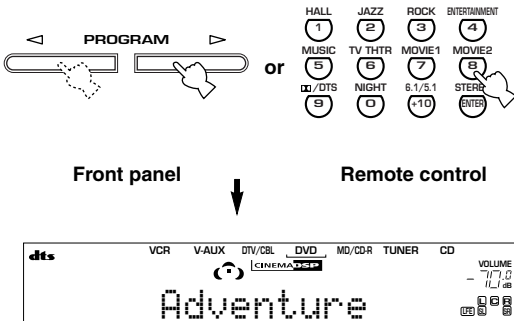

3 After selecting the desired program, press the same button repeatedly to cycle through sub-programs if available.

Example: Pressing MOVIE 2 repeatedly switches the sub-program between “Adventure” and “General”.

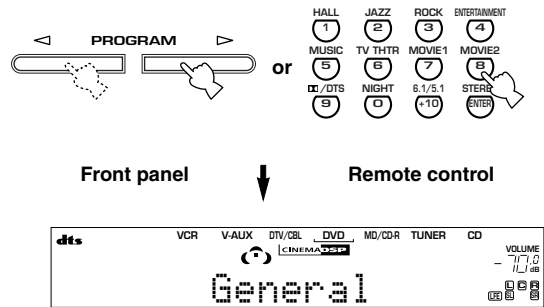

Notes

- There are 9 programs with sub-programs available with this unit. However, the selection depends on the input signal format and not all sub-programs can be used with all input signal formats.
- You cannot use the digital sound field processor with a source connected to the 6CH INPUT jacks of this unit or when the unit is reproducing a digital source with a sampling frequency greater than 48 kHz.
- The acoustics of your listening room affect sound field programs. Minimize sound reflections in your room to maximize the effect created by the program.
- When you select an input source, this unit automatically selects the last sound field program used with that source.
- When you set this unit in standby mode, it stores the current source and sound field program in memory and automatically selects them when you turn on the power again.
- If the unit receives a Dolby Digital or DTS signal when the input mode is set to AUTO, the sound field program (No. 7–9) automatically switches to the appropriate decoding program.
- When the unit is reproducing a monaural source with PRO LOGIC or PRO LOGIC/Enhanced, or PRO LOGIC II Movie, no sound is output from the front and surround speakers. Sound can only be heard from the center speaker. (If “1A CENTER” on the set menu is set to NONE, the center channel sound is output from the front speakers.)



- Select a program based on your listening preference. Program names are just for reference.

■ Selecting PRO LOGIC or PRO LOGIC II

You can listen to 2-channel sources decoded into four discrete channels by selecting PRO LOGIC or five discrete channels by selecting PRO LOGIC II in program No. 9 (refer to the list on page 32).

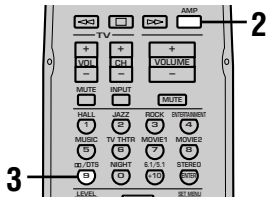

1 Select a 2-channel source and start playback on the source component.

2 Press AMP.



3 Press DTS.

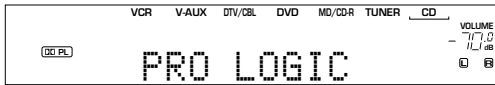

The display cycles as follows each time you press DTS/DTS:
 PRO LOGIC→PRO LOGIC Enhanced→PRO LOGIC II
 Movie→PRO LOGIC II Music→PRO LOGIC→....



- You can select PRO LOGIC, PRO LOGIC Enhanced, PRO LOGIC II Movie, and PRO LOGIC II Music by pressing PROGRAM <|> on the front panel repeatedly.

■ Playing Dolby Digital EX or DTS ES material

Press 6.1/5.1 to turn on the Dolby Digital + Matrix 6.1 or DTS + Matrix 6.1 decoder.



(Example)

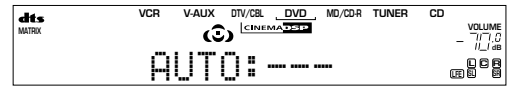

The display changes AUTO→Matrix 6.1→OFF each time 6.1/5.1 is pressed.

- AUTO:** Automatically switches Dolby Digital + Matrix 6.1 and DTS + Matrix 6.1 depending on the signal. Virtual surround back speaker does not work for 5.1-channel sources.
- Matrix 6.1:** Produces 6-channel playback of the input source using the Matrix 6.1 decoder. The virtual surround back speaker can be used when playing a 5.1-channel source.
- OFF:** Virtual surround back speaker does not work.

Notes

- Some 6.1-channel compatible discs do not have a signal (flag) that this unit can automatically detect. Select “Matrix 6.1” to play these kinds of discs with 6.1-channel sound.
- 6.1-channel playback is not possible even if you press 6.1/5.1 in the following cases:
 - When effects are turned off.
 - When the source connected to the 6CH INPUT jacks is being played.
 - When the unit is reproducing a Dolby Digital KARAOKE source.
 - When headphones are connected to the PHONES jack.
- The 6.1/5.1 setting resets to AUTO when you turn the unit power off.

■ Virtual CINEMA DSP

With Virtual CINEMA DSP, you can enjoy all sound field programs without surround speakers. It creates virtual speakers to reproduce a natural sound field.

You can listen to virtual CINEMA DSP by setting “1C SURR” in the set menu to NON. Sound field processing changes to Virtual CINEMA DSP automatically.

Note

- Virtual CINEMA DSP will not activate, even when 1C SURR is set to “NONE” (see page 42) in the following cases:
 - When the 5ch Stereo, DOLBY DIGITAL, Pro Logic, Pro Logic II, or DTS program is selected.
 - When the sound effect is turned off.
 - When 6CH INPUT is selected as the input source.
 - When a digital signal with a sampling frequency greater than 48 kHz is input to this unit.
 - When using the test tone.
 - When connecting the headphones.

■ To listen with headphones (SILENT CINEMA)

The SILENT CINEMA mode allows you to enjoy multi-channel music or movie sound, including Dolby Digital and DTS surround, through ordinary headphones.

SILENT CINEMA activates automatically whenever you connect headphones to the PHONES jack while listening to CINEMA DSP or HiFi DSP sound field programs. The “SILENT CINEMA” indicator lights up on the front panel display. (If the sound field programs are off, you listen with normal stereo reproduction.)

Notes

- This feature is not available when 6CH INPUT is selected or the unit is receiving a digital signal with a sampling frequency greater than 48 kHz.
- The sound from the LFE channel will be mixed and output from the headphones.

■ Normal stereo reproduction

Press STEREO to turn off the sound effect for normal stereo reproduction.

Press STEREO again to turn the sound effect back on.

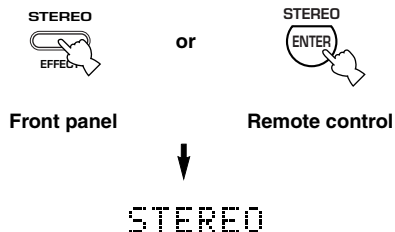

Notes

- If you turn off the sound effects, no sound is output from the center speaker or surround speakers.
- If you turn off the sound effects while the unit is reproducing sound from a Dolby Digital or DTS signal, the dynamic range of the signal is automatically compressed and the unit will mix the sounds of the center and surround speaker channels and output them from the front speakers.
- The volume may be greatly reduced when you turn off the sound effects or if you set “SOUND 4 D. RANGE (dynamic range)” on the set menu to MIN. In this case turn on the sound effect.



- During stereo reproduction, you can display information such as the type, format and sampling frequency of the signal input from the components connected to this unit.

(While playing a source)

- 1 Press AMP.
- 2 Press \wedge / \vee to display the information about the input signal.

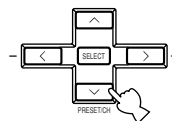

(Format): The display shows the signal format. When the unit cannot detect a digital signal it automatically switches to analog input.

in: The display shows the number of input signal source channels, as follows: For multi-channel soundtrack such as front 3 channels, surround 2 channels and LFE, the display shows “3/2/LFE”.

fs: The display shows the sampling frequency. When the unit is unable to detect the sampling frequency “Unknown” shows in the front panel display.

rate: The display shows the bit rate. When the unit is unable to detect the bit rate “Unknown” shows in the front panel display.

flg: The display shows the flag - data encoded in a DTS or Dolby Digital signal that causes this unit to automatically switch to the appropriate decoder for playback.

DIGITAL SOUND FIELD PROCESSING (DSP)

Understanding sound fields



A sound field is defined as the “characteristic sound reflections of a particular space.” In concert halls and other music venues, we hear early reflections and reverberations as well as the direct sound produced by the artist(s). The variations in the early reflections and other reverberations among the different music venues is what gives each venue its special and recognizable sound quality.

YAMAHA sent teams of sound engineers all around the world to measure the sound reflections of famous concert halls and music venues, and collect detailed sound field information such as the direction, strength, range, and delay time of those reflections. Then we stored this enormous amount of data in the ROM chips of this unit.

■ Recreating a sound field

Recreating the sound field of a concert hall or an opera house requires localizing the virtual sound sources in your listening room. The traditional stereo system that uses only two speakers is not capable of recreating a realistic sound field. YAMAHA’s DSP requires four effect speakers to recreate sound fields based on the measured sound field data. The processor controls the strength and delay time of the signals output from the four effect speakers to localize the virtual sound sources and fully encompass the listener.

HiFi DSP programs

The following list gives you a brief description of the sound fields produced by each of the sound field programs. Keep in mind that most of these are precise digital recreations of actual acoustic environments.

No.	Program	Features
1	CONCERT HALL (except China model)	A large round concert hall with a rich surround effect. Pronounced reflections from all directions emphasize the extension of sounds. The sound field has a great deal of presence, and your virtual seat is near the center, close to the stage.
	HALL IN CHINA (China model only)	A large, extremely famous concert hall in China with approx. 650 seats on the first floor and approx. 500 seats on the second floor. The clear sound field of this gorgeous and majestic hall is suited especially for classic music. Your virtual seat is near the center on the first floor.
2	JAZZ CLUB	This is the sound field at stage front in “The Bottom Line”, a famous New York jazz club, that seats up to 300 people. Its wide left to right seating arrangement offers a real and vibrant sound.
3	ROCK CONCERT	The ideal program for lively, dynamic rock music. The data for this program was recorded at LA’s “hottest” rock club. The listener’s virtual seat is at the center-left of the hall.
4	ENTERTAINMENT/ Disco	This program recreates the acoustic environment of a lively disco in the heart of a big city. The sound is dense and highly concentrated. It is also characterized by a high-energy, “immediate” sound.
	ENTERTAINMENT/ 5ch Stereo	Using this program increases the listening position range. This is a sound field suitable for background music at parties, etc.

CINEMA DSP

Sound design of CINEMA DSP

Filmmakers intend for the dialog to be located right on the screen, the effect sound a little farther back, the music spread even farther back, and the surround sound around the listener. Of course, all of these sounds must be synchronized with the images on the screen.

CINEMA DSP is an upgraded version of YAMAHA DSP specially designed for movie soundtracks. CINEMA DSP integrates the DTS, Dolby Digital, and Dolby Pro Logic surround sound technologies with YAMAHA DSP sound field programs to provide a surround sound field. It recreates comprehensive movie sound design in your audio room. In CINEMA DSP sound field programs, YAMAHA's exclusive DSP processing is added to the Front left and right, and Center channels, so the listener can enjoy realistic dialogue, depth of sound, smooth transition between sound sources, and a surround sound field that goes beyond the screen.

When a DTS or Dolby Digital signal is detected, the CINEMA DSP sound field processor automatically chooses the most suitable sound field program for that signal.

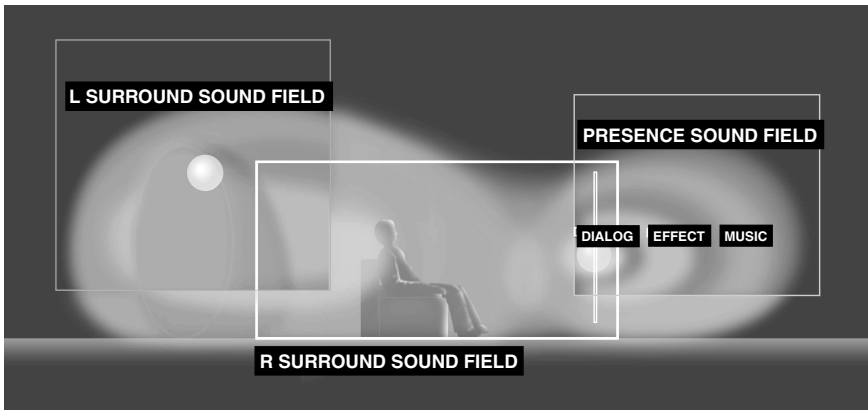

In addition to the DSP, this unit is equipped with a variety of precise decoders; Dolby Pro Logic decoder for Dolby Surround sources, Dolby Pro Logic II decoder for Dolby Surround and 2-channel sources, Dolby Digital/DTS decoder for multi-channel sources and Dolby Digital + Matrix 6.1 or DTS + Matrix 6.1 decoder for adding a surround back channel (the surround back channel is outputted from virtual surround back speaker). You can select CINEMA DSP programs to optimize these decoders and the DSP sound patterns depending on the input source.

CINEMA DSP Programs

The following list gives you a brief description of the sound fields produced by each of the sound field programs. Keep in mind that most of these are precise digital recreations of actual acoustic environments. Select the sound field program that you feel sounds best regardless of the name and description given for it below.

■ For audio-video sources: No. 4 to 6

No.	Program	Features
4	ENTERTAINMENT/ Game	This program adds a deep and spatial feeling to video game sounds.
5	MUSIC VIDEO	This program lends an enthusiastic atmosphere to the sound, giving you the feeling you are at an actual jazz or rock concert.
6	TV THEATER/ Mono Movie	This program is provided for reproducing monaural video sources (such as old movies). The program produces the optimum reverberation to create sound depth using only the presence sound field.
	TV THEATER/Variety/ Sports	Though the presence sound field is relatively narrow, the surround sound field employs the sound environment of a large concert hall. This effect enhances the experience of watching various TV programs such as news, variety shows, music programs or sports programs.

■ For movie programs

No.	Program		Features
7	MOVIE THEATER 1	Spectacle	This program creates the extremely wide sound field of a 70-mm movie theater. It precisely reproduces the source sound in detail, making both the video and the sound field incredibly real. This is ideal for any kind of video source encoded with Dolby Surround, Dolby Digital or DTS (especially large-scale movie productions).
		Sci-Fi	This program clearly reproduces dialog and sound effects in the latest sound form of science fiction films, thus creating a broad and expansive cinematic space amid the silence. You can enjoy science fiction films in a virtual-space sound field that includes Dolby Surround, Dolby Digital and DTS-encoded software employing the most advanced techniques.
8	MOVIE THEATER 2	Adventure	This program is ideal for precisely reproducing the sound design of the newest 70-mm and multichannel soundtrack films. The sound field is made to be similar to that of the newest movie theaters, so the reverberations of the sound field itself are restrained as much as possible.
		General	This program is for reproducing sounds from 70-mm and multichannel soundtrack films, and is characterized by a soft and extensive sound field. The presence sound field is relatively narrow. It spatially spreads all around and toward the screen, restraining the echo effect of conversations without losing clarity.
9	Straight Decode		The built-in decoder reproduces source sounds and sound-effects precisely. No DSP effect is applied in this program.
	Enhanced Mode		This program ideally simulates the multi-surround speaker systems of the 35-mm film theaters. Dolby Pro Logic decoding, Dolby Digital decoding or DTS decoding and digital sound field processing create precise effects without altering the original sound orientation. The surround effects produced by this sound field wrap around the viewer naturally from the back to the left and right, and toward the screen.

Straight Decode

This unit is equipped with various precise decoders;

- Dolby Digital/DTS decoder for multi-channel reproduction of the original sound
- Dolby Pro Logic/Pro Logic II decoder for multi-channel reproduction of 2-channel sources

Select any of the Straight Decode modes in Program No. 9 (except for the sub-program “Enhanced”) as shown in the above list to use any of these decoders for reproducing the original sound without any sound effects added. In this case, no DSP effect is applied and the DSP indicator turns off.

Note

- When playing a monaural source with a CINEMA DSP program, the source signal is directed to the center channel, and the front and surround speakers output effect sounds.

Sound field effects

The 6-channel soundtracks found on 70-mm film produce precise sound field localization and rich, deep sound without using matrix processing. This unit's MOVIE THEATER programs provide the same quality of sound and sound localization that 6-channel soundtracks do. The built-in Dolby Digital or DTS decoder brings the professional-quality sound designed for movie theaters into your home. With this unit's MOVIE THEATER programs, you can use Dolby Digital or DTS technology to recreate a dynamic sound that gives you the feeling of being in a public theater.

■ Dolby Digital/DTS + DSP sound field effect

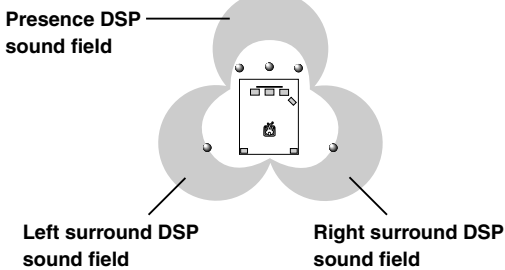

These programs use YAMAHA's tri-field DSP processing on each of the Dolby Digital or DTS signals for the front, left surround, and right surround channels. This processing enables this unit to reproduce the immense sound field and surround expression of a Dolby Digital- or DTS-equipped movie theater without sacrificing the clear separation of all channels.

■ Dolby Digital/DTS + Matrix 6.1 + DSP sound field effect

These programs provide you with the maximum experience of the spacious surround effects by adding an extra surround back DSP sound field created from the virtual surround back speaker.

■ Dolby Pro Logic + DSP sound field effect

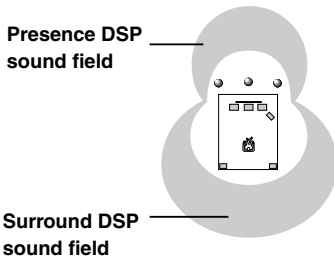

Most movie material has 4-channel (left, center, right, and surround) sound information encoded by Dolby Surround matrix processing and stored on the left and right tracks. These signals are processed by the Dolby Pro Logic decoder. The MOVIE THEATER programs are designed to recreate the spaciousness and delicate nuances of sound that tend to be lost in the encoding and decoding processes.

■ Dolby Pro Logic II

Dolby Pro Logic II decodes Dolby Surround software into 5 discrete full-range channels (3 channels in front and 2 channels in surround). There are 2 modes; MOVIE for movies and MUSIC for 2-channel audio sources.

TUNING

There are 2 methods of tuning; automatic and manual. Automatic tuning is effective when station signals are strong and there is no interference.

■ Automatic tuning

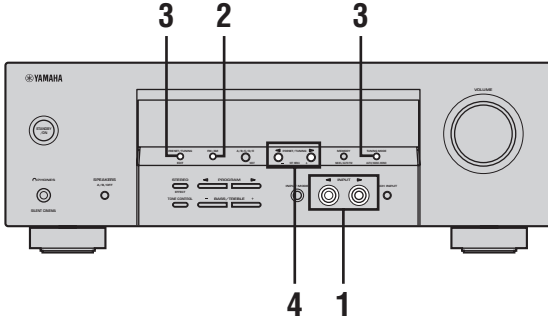

- 1 Press **INPUT** $\triangleleft/\triangleright$ (or **TUNER** on the remote control) to select **TUNER** as the input source.

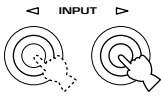

Front panel

or



Remote control

- 2 Press **FM/AM** to select the reception band. “FM” or “AM” appears on the front panel display.

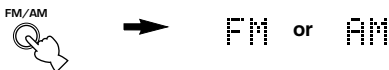

- 3 Press **TUNING MODE (AUTO/MAN'L MONO)** so that the “AUTO” indicator lights up on the front panel display.



If the colon (:) appears on the front panel display, tuning is not possible. Press **PRESET/TUNING (EDIT)** to turn it off.

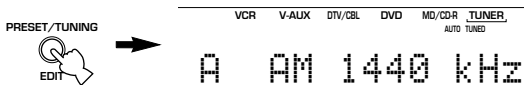

- 4 Press **PRESET/TUNING** $\triangleleft/\triangleright$ once to begin automatic tuning.

Press \triangleright to tune in to a higher frequency, or press \triangleleft to tune in to a lower frequency.

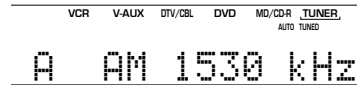

When the unit is tuned in to a station, the “TUNED” indicator lights up and the frequency of the station received is shown on the front panel display.

■ Manual tuning

If the signal from the station you are trying to select is weak, tune in to it manually.

- 1 Select **TUNER** and the reception band following steps 1 and 2 described in “Automatic tuning” at left.

- 2 Press **TUNING MODE (AUTO/MAN'L MONO)** until the “AUTO” indicator disappears from the front panel display.



If the colon (:) appears on the front panel display, tuning is not possible. Press **PRESET/TUNING (EDIT)** to turn it off.

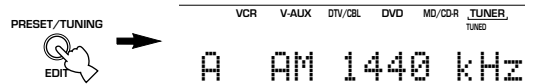

- 3 Press **PRESET/TUNING** $\triangleleft/\triangleright$ to tune in to the desired station manually.

Hold down the button to continue searching.

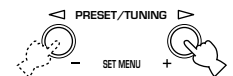

Note

- Manually tuning in to an FM station will automatically change the reception mode to monaural to increase the signal quality.

Presetting stations

■ Automatically presetting FM stations

You can use the automatic preset tuning feature to store FM stations. This function enables the unit to automatically tune in to FM stations with strong signals, and to store up to 40 (8 stations in 5 groups, A1 through E8) of those stations in order. You can then recall any preset station easily by selecting the preset number.

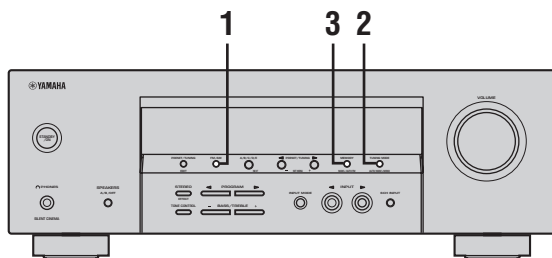

1 Press FM/AM to select the FM band.



2 Press TUNING MODE (AUTO/MAN'L MONO) until the "AUTO" indicator lights up on the front panel display.



3 Press and hold MEMORY (MAN'L/AUTO FM) for more than 3 seconds.

The preset number, the "MEMORY" and "AUTO" indicators flash. After about 5 seconds, automatic presetting starts from the frequency currently displayed and proceeds toward the higher frequencies.

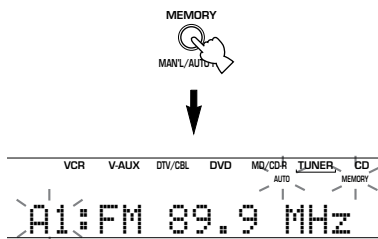

When automatic preset tuning is completed, the front panel display shows the frequency of the last preset station.

Notes

- Any stored station data existing under a preset number is cleared when you store a new station under that preset number.
- If the number of the received stations does not reach 40 (E8), automatic preset tuning has automatically stopped after searching all stations.
- Only FM stations with sufficient signal strength are stored automatically by automatic preset tuning. If the station you want to store is weak in signal strength, tune in to it manually in the monaural mode, and store it by following the procedure described in "Manually presetting stations" on page 36.

Automatic preset tuning options

You can select the preset number from which this unit will store FM stations and/or begin tuning toward lower frequencies.

After pressing MEMORY in step 3:

- 1 Press A/B/C/D/E, then PRESET/TUNING ◀/▶ to select the preset number under which the first station will be stored. Automatic preset tuning will stop when stations have all been stored up to E8.
- 2 Press PRESET/TUNING (EDIT) to turn off the colon (:), and then press PRESET/TUNING ◀ to begin tuning toward lower frequencies.

Memory back-up

The memory back-up circuit prevents the stored data from being lost even if this unit is set in the standby mode, the power cord is disconnected from the AC outlet, or the power supply is temporarily cut due to power failure. However, if the power is cut for more than one week, the preset stations may be cleared. If so, store the stations again by using the presetting station methods.

Manually presetting stations

You can store up to 40 stations (8 stations x 5 groups) manually.

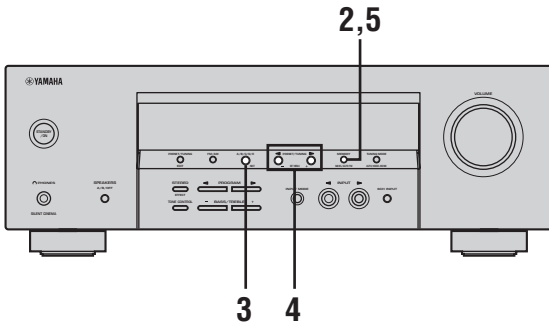

1 Tune in to a station.

See page 34 for tuning instructions.

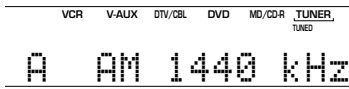

When tuned in to a station, the front panel display shows the frequency of the station received.

2 Press MEMORY (MAN'L/AUTO FM).

The "MEMORY" indicator flashes for about 5 seconds.

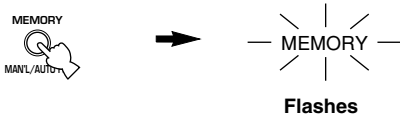

3 Press A/B/C/D/E repeatedly to select a preset station group (A to E) while the "MEMORY" indicator is flashing.

The group letter appears. Check that the colon (:) is showing on the front panel display.

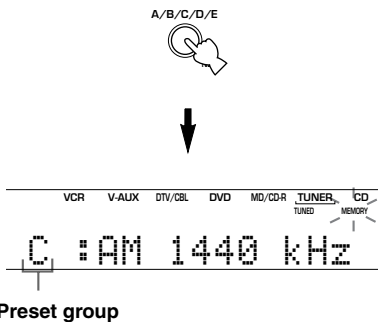

4 Press PRESET/TUNING </> to select a preset station number (1 to 8) while the "MEMORY" indicator is flashing.

Press > to select a higher preset station number. Press < to select a lower preset station number.

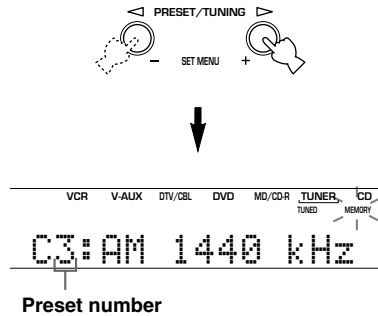

5 Press MEMORY (MAN'L/AUTO FM) on the front panel while the "MEMORY" indicator is flashing.

The station band and frequency appear on the front panel display with the preset group and number you have selected.

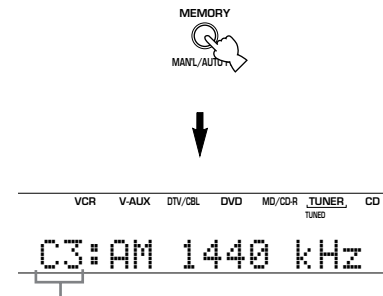

Shows the displayed station has been stored as C3.

6 Repeat steps 1 to 5 to store other stations.

Notes

- Any stored station data existing under a preset number is cleared when you store a new station under that preset number.
- The reception mode (stereo or monaural) is stored along with the station frequency.

Selecting preset stations

You can tune any desired station simply by selecting the preset station number under which it was stored.

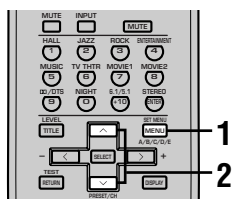
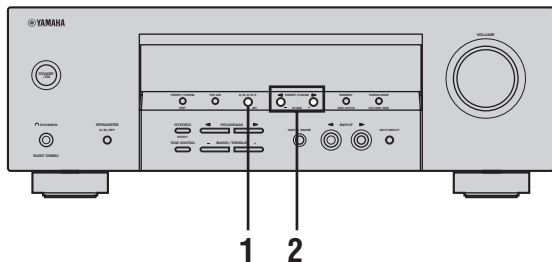

- 1 Press A/B/C/D/E (or A/B/C/D/E on the remote control) to select the preset station group. The preset group letter appears on the front panel display and changes each time you press A/B/C/D/E.



Front panel

or



Remote control

- 2 Press PRESET/TUNING </> (or PRESET ^ / v on the remote control) to select a preset station number (1 to 8). The preset group and number appear on the front panel display along with the station band, frequency and the "TUNED" indicator lights up.

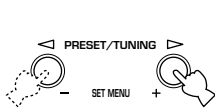

Front panel

or

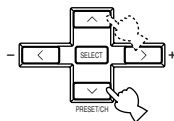

Remote control

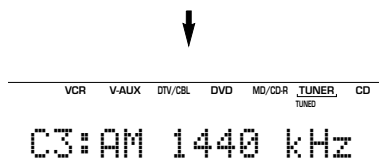

Exchanging preset stations

You can exchange the assignment of two preset stations with each other. The example below describes the procedure for exchanging preset station "E1" with "A5".

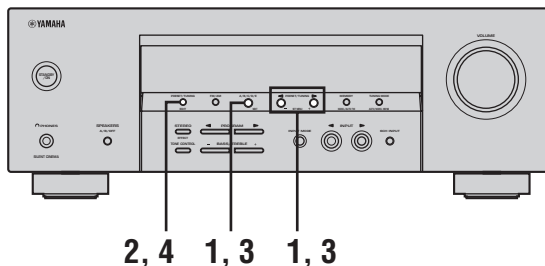

- 1 Select preset station "E1" using A/B/C/D/E and PRESET/TUNING </>. See "Selecting preset stations" at left.
- 2 Press and hold PRESET/TUNING (EDIT) for more than 3 seconds. "E1" and the "MEMORY" indicator flash on the front panel display.

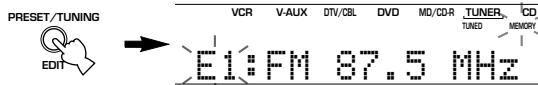

- 3 Select preset station "A5" using A/B/C/D/E and PRESET/TUNING </>. "A5" and the "MEMORY" indicator flash on the front panel display.

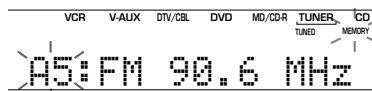

- 4 Press PRESET/TUNING (EDIT) again. The stations stored at the two preset assignments are exchanged.

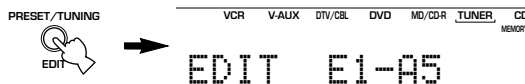

Shows the exchange of stations has been completed.

SLEEP TIMER

Use this feature to automatically set this unit in the standby mode after a certain amount of time. The sleep timer is useful when you are going to sleep while this unit is playing or recording a source.

The sleep timer can only be set with the remote control.



- By connecting a commercially available timer to this unit, you can also set a wake-up timer. Refer to the operation instructions of the timer.

■ Setting the sleep timer

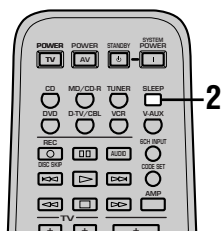

1 Select a source and start playback on the source component.

2 Press SLEEP repeatedly to set the amount of time.

Each time you press SLEEP, the front panel display changes as shown below. The SLEEP indicator flashes while switching the amount of time for sleep timer.

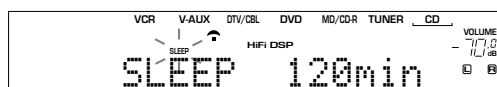
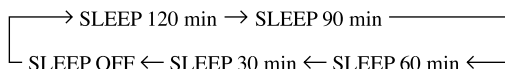

3 The "SLEEP" indicator lights up on the front panel display after the sleep timer has been set.

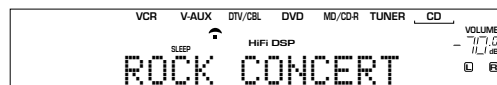

■ Canceling the sleep timer

Press SLEEP repeatedly until "SLEEP OFF" appears on the front panel display.

After a few seconds, "SLEEP OFF" disappears, and the "SLEEP" indicator goes off.

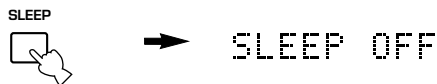

The sleep timer setting can also be canceled by pressing STANDBY on the remote control (or STANDBY/ON on the front panel) to set this unit to the standby mode.

RECORDING

Recording adjustments and other operations are performed on other recording components. Refer to the operation instructions for these components for details on their operation .

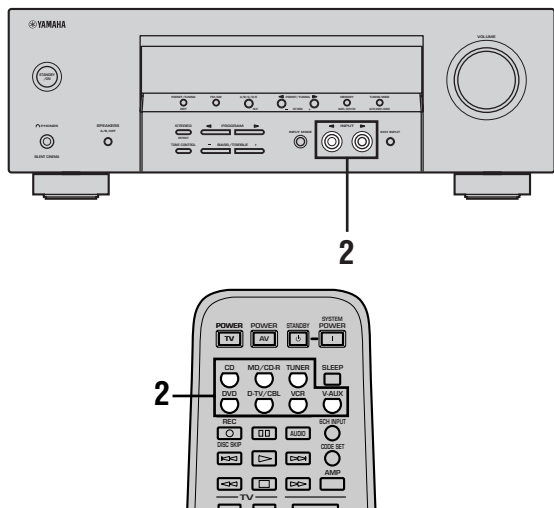

Notes

- Do a test recording before you start an actual recording.
- When this unit is set in the standby mode, you cannot record between other components connected to this unit.
- The setting of TONE CONTROL, VOLUME, “SP LEVEL” (page 23) and programs does not affect the recorded material.
- A source connected to the 6CH INPUT jacks of this unit cannot be recorded.
- A given input source is not output on the same REC OUT channel. (For example, the signal input from VCR 1 IN is not output on VCR 1 OUT.)
- Check the copyright laws in your country to record from records, CDs, radio, etc. Recording of copyrighted material may infringe copyright laws.

If you playback a video source that uses scrambled or encoded signals to prevent it from being dubbed, the picture itself may be disturbed due to those signals.

- 1 Turn on the power of this unit and all connected components.
- 2 Select the source component you want to record from.

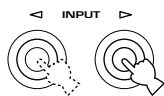

Front panel

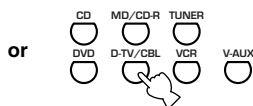

Remote control

- 3 Start playback (or select a broadcast station) on the source component.
- 4 Start recording on the recording component.

SET MENU

You can set the following parameters on the set menu to obtain a better sound from the unit. Change the settings to reflect the needs of your listening environment.

Set menu list

The set menus are divided by use and function into the 4 categories listed here.

■ BASIC MENU

The BASIC MENU contains the basic parameters that you must set before using this unit. It consists of the following menus. See pages 21 – 23 for a detailed explanation.

1 SETUP

2 SP LEVEL (Speaker level)

■ SOUND MENU

The SOUND MENU contains parameters for altering sound output. It consists of the following menus that you can use to alter the quality and tone of the sound output by the system.

1 SPEAKER SET

2 SP DISTANCE (Speaker distance)

3 LFE LEVEL (Low frequency effect level)

4 D. RANGE (Dynamic range)

5 CENTER GEQ (Center graphic equalizer)

6 HP TONE CTRL (Headphone tone control)

■ INPUT MENU

The INPUT MENU contains parameters concerned with signal input. It consists of the following menus that you can use to change the assignment of input jacks.

1 I/O ASSIGN

2 INPUT MODE

■ OPTION MENU

This is a supplementary set up menu provided for your convenience. It consists of the following menus that you can use to change display brightness, protect existing settings, and perform other non-essential functions.

1 DISPLAY SET

2 MEM. GUARD

3 AUDIO MUTE

- In the descriptions for each item from the following page, the default setting is indicated in bold.

Adjusting the items on the set menu

Use the remote control to make adjustments.

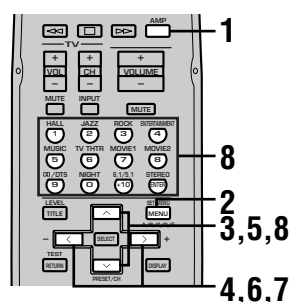

- You can change set menu parameters while the unit is reproducing sound.
- You can use NEXT and SET MENU +/- on the front panel to change these settings, if the unit is not set to TUNER mode. Press NEXT to select the category or field you wish to change, and SET MENU +/- to change the parameters.

Note

- You cannot change some set menu parameters while the unit is in night listening mode.

1 Press AMP.



2 Press SET MENU to enter the set menu.



3 Press ^ / v repeatedly to select the desired menu.

4 Press < / > to enter the selected menu.

5 Press ^ / v repeatedly to select the item you want to adjust.

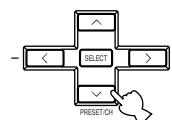

- By pressing SET MENU repeatedly, you can select items in the same order as when pressing v.

6 Press </> once to enter the setup mode of the selected item.

The last setting you adjusted appears on the front panel display.

Depending on the menu item, press ^/∨ to select a sub item.

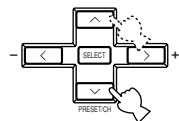
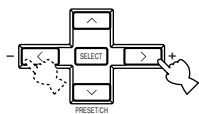

7 Press </> repeatedly to change the menu item setting.

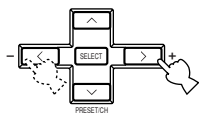

8 To exit, press ^/∨ repeatedly until the menu disappears or just press one of the sound field program group buttons.

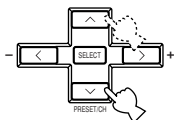

or

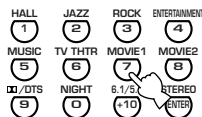

SOUND 1 SPEAKER SET
(speaker mode settings)

Use this feature to select suitable output modes for your speaker configuration.

Note

- Some menu item settings have no effect when the unit is reproducing a source with a digital signal sampling frequency greater than 48 kHz.

1A CENTER (center speaker mode)

If you add a center speaker to your speaker configuration, this unit can provide better dialog localization for several listeners and superior synchronization of sound and images.

Choices: LRG (large), SML (small), NON (none)

LRG

Select this if you have a large center speaker. The unit directs the entire range of the center channel signal to the center speaker.

SML

Select this if you have a small center speaker. The unit directs the low-frequency signals (90 Hz and below) of the center channel to the speakers selected with "ID BASS".

NON

Select this if you do not have a center speaker. The unit directs all of the center channel signal to the front left and right speakers.

Memory back-up

The memory back-up circuit prevents the stored data from being lost even if this unit is in standby mode. However, if the power cord is disconnected from the AC outlet, or the power supply is cut for more than one week, the stored data will be lost. If this happens, adjust the items again.

The BASIC and SOUND menus

The "BASIC" menu allows you to easily set the "SOUND 1 SPEAKER SET" and "SOUND 2 SP DISTANCE" parameters. It is not necessary to reset any of the parameters in the "BASIC" menu, but you can access more detailed parameters in the "SOUND" menu if you wish.

Note

- After altering parameters in the "SOUND" menu, if you select "BASIC 1 SETUP" and then select "SET", the parameters from the "SOUND" menu alter in response to any changes you make in "BASIC 1 SETUP". Do not enter the "BASIC 1 SETUP" menu unless you wish to change these settings. If you accidentally enter the "BASIC 1 SETUP" menu, select CANCEL to return to the "BASIC" menu. (page 22)

■ 1B FRONT (front speaker mode)

Choices: **LRG** (large), **SML** (small)

LRG

Select this if you have large front speakers. The unit directs the entire range of the front left and right channel signals to the front left and right speakers.

SML

Select this if you have small front speakers. The unit directs the low-frequency signals (90Hz and below) of the front channel to the speakers selected with "1D BASS".

■ 1C SURR (surround speaker mode)

Choices: **LRG** (large), **SML** (small), **NON** (none)

LRG

Select this if you have large surround left and right speakers. The entire range of the surround channel signal is directed to the surround left and right speakers.

SML

Select this if you have small surround left and right speakers. The low-frequency signals (90Hz and below) of the surround channel are directed to the speakers selected with "1D BASS".

NON

Select this if you do not have surround speakers. This unit is set in the virtual CINEMA DSP mode when you select **NON** for "1C SURR".

■ 1D BASS (bass out mode)

LFE signals carry low-frequency effects when this unit decodes a Dolby Digital or DTS signal. The Low-frequency signals can be directed to both front left and right speakers, and to the subwoofer (subwoofer can be used for both stereo reproduction and the sound field program).

Choices: **SWFR** (subwoofer), **FRNT**, **BOTH**

SWFR

Select **SWFR** if you connect a subwoofer. LFE and low-frequency signals from other channels are directed to the subwoofer according to the speaker settings.

FRNT

Select **FRNT** if you do not use a subwoofer. LFE and low-frequency signals from other channels are directed to the front speakers according to the speaker settings (even if you have previously set the front speakers to **SML**).

BOTH

Select **BOTH** if you connect a subwoofer and you want to output low-frequency signals from front channels to both front speakers and the subwoofer. LFE and low-frequency signals from other channels are directed to the subwoofer according to the speaker settings.

Use this function to reinforce low-frequency signals using the subwoofer when playing back source such as CDs.

Note

- When you select **FRNT** for "1D BASS", the unit directs the low-frequency signals (90Hz and below) of the front channel to the front speakers even if you select **SML** for the front speaker mode.

SOUND 2 SP DISTANCE (speaker distance)

Use this feature to manually input the distance of each speaker and adjust the delay applied to respective channel. Ideally, each speaker should be the same distance from the main listening position. However, this is not possible in most home situations. Thus, a certain amount of delay must be applied to the sound from each speaker so that all sound will arrive at the listening position at the same time.

- 1 Press \wedge / \vee to select "UNIT".
- 2 Press \langle / \rangle to select the unit "meters" or "feet" to be used in setting.
- 3 Press \wedge / \vee to select a speaker.
- 4 Press \langle / \rangle to set the distance.
Press \rangle for higher values and \langle for lower values.

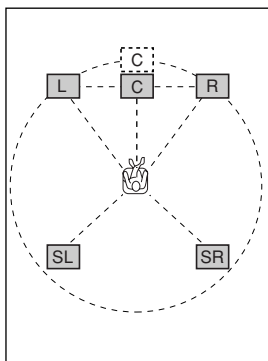

■ Setting by "meters"

Control range: 0.30 to 24.00 m (for front L/R, center, surround L/R)

Initial settings: 3.00 m (for front L/R, center, surround L/R)

■ Setting by "feet"

Control range: 1.0 to 80.0 ft (for front L/R, center, surround L/R)

Initial settings: 10.0 ft (for front L/R, center, surround L/R)

Note

- No delay will be set if you set the same distance for the front L/R and center, or the surround L/R.

SOUND 3 LFE LEVEL

Use to adjust the output level of the LFE (low-frequency effect) channel according to the capacity of your subwoofer or headphones. The LFE channel carries low-frequency special effects which are only added to certain scenes. This setting is effective only when this unit decodes Dolby Digital or DTS signals.

Control range:

SP LFE (Speaker) -20 to 0 dB

HP LFE (Headphone) -20 to 0 dB

Initial setting: 0 dB

- 1 Press \wedge / \vee to select the item to be adjusted.
- 2 Press \langle to adjust the LFE level.

Note

- Adjust the LFE level according to the capacity of your subwoofer or headphones.

SOUND 4 D. RANGE (dynamic range)

Use this feature to adjust the dynamic range. This setting is effective only when the unit is decoding Dolby Digital signals.

Choices: **MAX** (maximum), **STD** (standard), **MIN** (minimum)

MAX

Select MAX for feature films.

STD

Select STD for general use.

MIN

Select MIN for listening to sources at low volume levels.

SOUND 5 CENTER GEQ (center graphic equalizer)

Use this feature to adjust the built-in 5-band graphic equalizer so that the center speaker tonal quality matches that of the left and right front speakers. You can select the 100 Hz, 300 Hz, 1 kHz, 3 kHz, or 10 kHz frequencies. Control range (dB): -6 to +6 Initial setting: 0 dB for 5-band

1 Press \vee to select a higher frequency and \wedge to select a lower frequency.

2 Press \langle / \rangle to adjust the level of that frequency.

Note

- You can monitor the center speaker sound while adjusting this parameter by using the test tone. Press TEST before starting the foregoing procedure. Once you begin this procedure, the test tone remains at the center speaker and you can hear how the sound changes as you adjust the various frequency levels. To stop the test tone, press TEST.

SOUND 6 HP TONE CTRL (headphone tone control)

Use this feature to adjust the level of the bass and treble when you are using headphones.

Control range (dB):

HP BASS -6 to +3

HP TRBL (treble) -6 to +3

Initial setting:

HP BASS 0 dB

HP TRBL 0 dB

INPUT 1 I/O ASSIGN (input/output assignment)

You can assign jacks according to the component to be used if this unit's initial settings do not correspond to your needs. Change the following parameters to reassign the respective jacks and effectively connect more components. Once the inputs have been reassigned, you can select the corresponding component by using INPUT \langle / \rangle on the front panel or the input selector buttons on the remote control.

For COMPONENT VIDEO jacks A (1A[A]) and B (1A[B])

Choices: [A] VCR, V-AUX, DTV/CBL, DVD

[B] VCR, V-AUX, DTV/CBL, DVD

For OPTICAL INPUT jacks 1 (1B(1)) and 2 (1B(2))

Choices: (1) VCR, V-AUX, DTV/CBL, DVD, MD/CD-R, CD

(2) VCR, V-AUX, DTV/CBL, DVD, MD/CD-R, CD

For COAXIAL INPUT jack 3 (1C(3))

Choices: VCR, V-AUX, DTV/CBL, DVD, MD/CD-R, CD

Notes

- You cannot select a specific item more than once for the same type of jack.
- When you connect a component to both the COAXIAL and OPTICAL jacks, priority is given to the input signals from the COAXIAL jack.

INPUT 2 INPUT MODE (initial input mode)

Use this feature to designate the input mode for sources connected to the DIGITAL INPUT jacks when you turn on this unit (see page 26 for details about the input mode).

Choices: **AUTO**, **LAST**

AUTO

Select this setting to allow the unit to automatically detect the type of input signal and select the appropriate input mode.

LAST

Select this setting to set this unit to automatically select the last input mode used for the respective sources.

OPTION 1 DISPLAY SET

■ DIMMER

Use this to adjust the brightness of the front panel display.

Control range: -4 to 0

OPTION 2 MEM. GUARD (memory guard)

Use this feature to prevent accidental changes to sound field program parameter values and other system settings.

Choices: ON, **OFF**

Select ON to protect:

- Sound field program parameters
- All SET MENU items
- All speaker levels

When MEMORY GUARD is set to ON, you cannot use the test tone or select any other SET MENU items.

OPTION 3 AUDIO MUTE

Use to adjust how much the mute function reduces the output volume.

Choices: **MUTE**, -50dB, -20dB

MUTE

Completely halts all output of sound.

-50dB

Reduces the volume of the present sound output by 50dB.

-20dB

Reduces the volume of the present sound output by 20dB.

ADVANCED SETUP MENU

The ADVANCED SETUP menu is displayed in the front panel display.



- During the advanced setup procedure, audio output is muted.
- During the advanced setup procedure, only the STANDBY/ON, STRAIGHT (EFFECT) and PROGRAM <◁/▷> buttons on the front panel are available for operation.

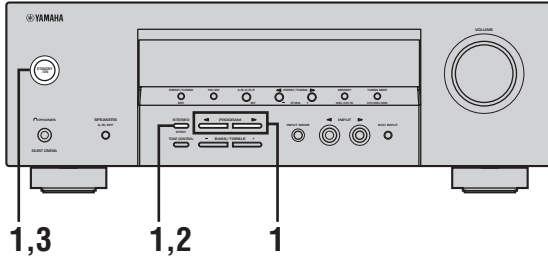

1 Turn off the power to this unit, and while holding down STEREO (EFFECT), press STANDBY/ON.

This unit turns on, and “PRESET” appears in the front panel display.

If you are using Asia and General model, you can select the menu by pressing PROGRAM <◁/▷>.



While holding down, press



PRESET

2 Press STEREO (EFFECT) repeatedly to toggle between the available parameters.



3 Press STANDBY/ON to confirm your selection.



This completes the advanced setup procedure. The settings you made are reflected the next time this unit's power is turned on.

■ ADVANCED SETUP menu items

Change the initial settings (indicated in bold under each parameter) to reflect the needs of your listening environment.

Factory presets PRESET

Use to reset all parameters to the factory presets (see page 57).

Choices: **CANCEL**, RESET

- Select **CANCEL** if you do not want this unit's parameters to be initialized.
- Select **RESET** if you want all of this unit's parameters to be initialized.

Note

- This setting does not affect ADVANCED SETUP menu item parameters.

< Asia and General models only >

Tuner TU

Use to switch the frequency step selection according to the frequency spacing in your area.

Choices: **AM10/FM100**, AM9/FM50

- North, Central and South America: AM10/FM100 (kHz)
- Other areas: AM9/FM50 (kHz)

REMOTE CONTROL FEATURES

In addition to controlling this unit, the remote control can also operate other A/V components made by YAMAHA and other manufacturers. To control other components, you must set up remote control with the appropriate remote control codes.

Control area

■ Controlling this unit

The shaded areas below can be used to control this unit when the AMP mode is selected. Press AMP to select the AMP mode.

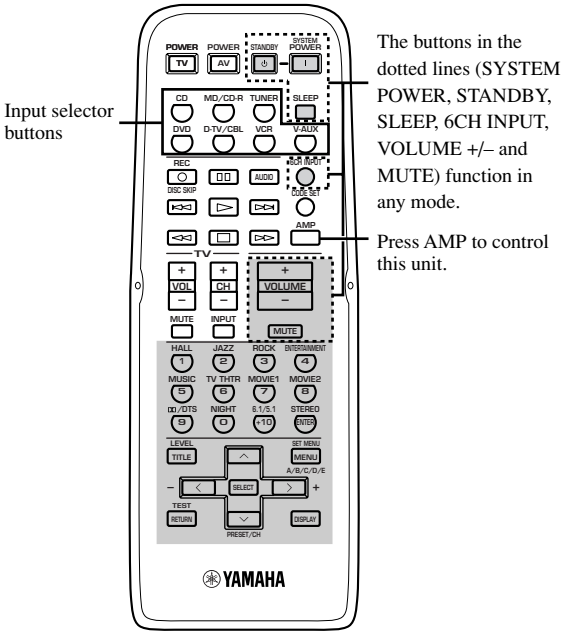

■ Controlling other components

The shaded areas below can be used to control other components. Each button has a different function depending on the selected components. Select the component you want to control by pressing an input selector button.

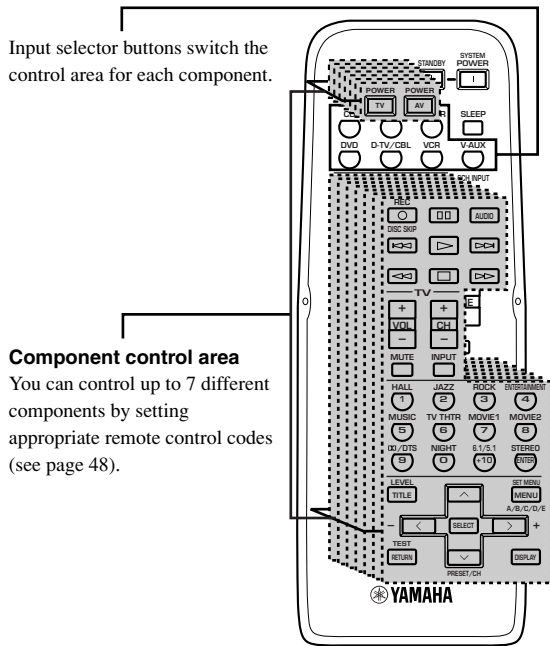

ADVANCED
OPERATION

Setting remote control codes

You can control other components by setting the appropriate remote control codes. Codes can be set up for each input area.

The following table shows the default component (Library: component category) and the remote control code for each area.

Input area	Component category (Library)	Manufacturer	Code
CD	CD player	YAMAHA	199
MD/CD-R	CD recorder	YAMAHA	499
TUNER* ¹	Tuner	YAMAHA	Fixed
DVD	DVD player	YAMAHA	699
D-TV/CBL* ²	–	–	–
V-AUX	–	–	–
VCR	–	–	–

*¹ You can control this unit and other Yamaha tuners only.

*² You can only set TV remote control codes for the D-TV/CBL buttons.

- 1 Press and hold CODE SET. With CODE SET depressed, press an input selector button to select the component you want to set up.**

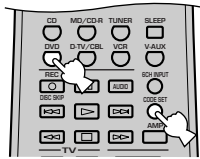

Note

- You must press and hold CODE SET throughout this procedure.

- 2 With CODE SET depressed, use the numeric buttons to enter the 3 digit code of your component's manufacturer.**

- Refer to the LIST OF REMOTE CONTROL CODES at the end of this manual.
- To reset the code, enter the factory-set code for each component shown in the above table.

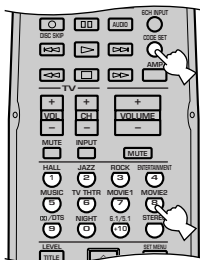

Notes

- If the manufacturer of your component has more than one code, try each of them until you find the correct one.
- You can only assign one remote control code to each input selector button.

Controlling other components

Once you set the appropriate remote control codes, you can use this remote to control your other components. Note that some buttons may not correctly operate the selected component. Use the input selector buttons to select the component you want to operate. The remote control automatically switches to the appropriate control mode for that component.

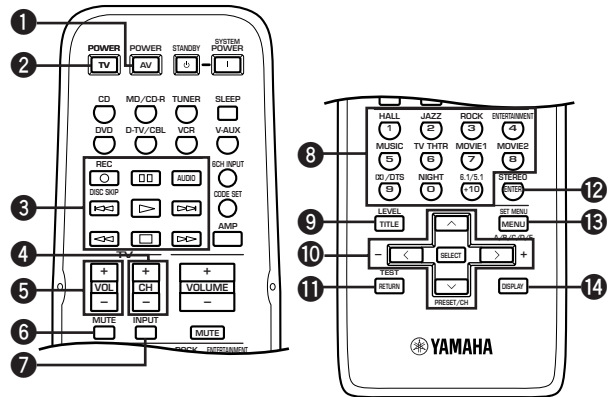

	DVD player	VCR	TV, digital/cable TV	CD player	CD/MD recorder	Tuner
1 AV POWER	* ¹ Power	* ¹ Power	* ³ VCR power	* ¹ Power	* ¹ Power	* ¹ Power
2 TV POWER	* ² TV power	* ² TV power	* ² TV power	* ² TV power	* ² TV power	* ² TV power
3 REC/DISC SKIP	Disc skip	Rec	* ³ VCR rec	Disc skip	Rec (MD)	
▷	Play	Play	* ³ VCR play	Play	Play	
◁	Search backward	Search backward	* ³ VCR search backward	Search backward	Search backward	
▷	Search forward	Search forward	* ³ VCR search forward	Search forward	Search forward	
AUDIO	Audio					
⏸	Pause	Pause	* ³ VCR pause	Pause	Pause	
◁	Skip backward			Skip backward	Skip backward	
▷	Skip forward			Skip forward	Skip forward	
□	Stop	Stop	* ³ VCR stop	Stop	Stop	
4 TV CH +	* ² TV channel up	* ² TV channel up	TV channel up	* ² TV channel up	* ² TV channel up	* ² TV channel up
TV CH -	* ² TV channel down	* ² TV channel down	TV channel down	* ² TV channel down	* ² TV channel down	* ² TV channel down
5 TV VOL +	* ² TV volume up	* ² TV volume up	TV volume up	* ² TV volume up	* ² TV volume up	* ² TV volume up
TV VOL -	* ² TV volume down	* ² TV volume down	TV volume down	* ² TV volume down	* ² TV volume down	* ² TV volume down
6 TV MUTE	* ² TV mute	* ² TV mute	TV mute	* ² TV mute	* ² TV mute	* ² TV mute
7 TV INPUT	* ² TV input	* ² TV input	TV input	* ² TV input	* ² TV input	* ² TV input
8 1-9, 0, +10	Numeric buttons	Numeric buttons	Numeric buttons	Numeric buttons	Numeric buttons	Preset stations (1-8)
9 TITLE	Title					
10 PRESET/CH ^	Up	VCR channel up				Preset up
PRESET/CH v	Down	VCR channel down				Preset down
PRESET/CH <	Left					
PRESET/CH >	Right					
SELECT	Select					
11 RETURN	Return					
12 ENTER	Title/Index	Enter	Enter	Index	Index	
13 MENU	Menu			Menu		A/B/C/D/E
14 DISPLAY	Display		Display	Display	Display	

*¹ This button functions only when the original remote control of the component has a POWER button.

*² These buttons can operate your TV without switching the input if the remote control code is set in D-TV/CBL.

*³ These buttons can operate your VCR without switching the input to VCR if the remote control code is set in VCR.

SETTING THE SPEAKER LEVELS

Adjusting the speaker levels during playback

You can adjust the output level of each speaker while listening to sound playback.

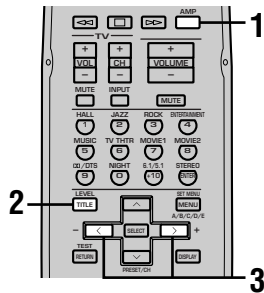

1 Press AMP.

2 Press LEVEL repeatedly to select the speaker you want to adjust.

The unit cycles through the speakers in the following order each time you press LEVEL:
FRONT L→CENTER→FRONT R→
SUR R. (surround R)→SUR L. (surround L)→
SWFR (subwoofer)→.....



- Pressing LEVEL once opens the level display. Press \wedge / \vee at this time to select a speaker.

3 Press \langle / \rangle to adjust the speaker output level.

- The center and surround speakers can be adjusted by a maximum of $-10\text{dB} \sim +10\text{dB}$.
- The front speakers and subwoofer can be adjusted by a maximum of $-20\text{dB} \sim 0\text{dB}$.

Notes

- You cannot adjust speaker levels if the "SOUND 1 SPEAKER SET" parameter in the set menu is set to NONE.
- You cannot adjust the subwoofer level if the "1D BASS" parameter in "SOUND 1 SPEAKER SET" in the set menu is set to FRNT.
- If you use LEVEL to adjust speaker levels, the speaker levels you previously set with the test tone will also change.
- If you select "BASIC 1 SETUP" in the set menu and then select "SET", speaker levels change in response to any changes you make in "BASIC 1 SETUP".

Using the test tone

Use the test tone to set speaker levels so that the volume from each speaker is identical when heard from your listening position.

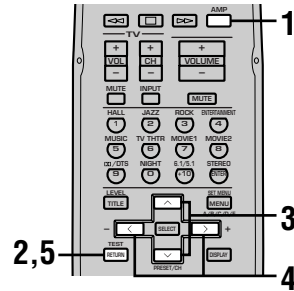

1 Press AMP.

2 Press TEST.

The unit will output a test tone.

3 Press \wedge / \vee repeatedly to select a speaker to adjust.

Each time you press \vee , the unit will cycle through the speakers in the following order:
TEST LEFT (front L)→TEST CENTER (center)→
TEST RIGHT (front R)→TEST SUR.R (surround R)→TEST SUR.L (surround L)→TEST SUBWOOFER (subwoofer)→.....
(Press \wedge to cycle the speakers in the reverse order.)

4 Press \langle / \rangle to adjust the speaker output level.

5 Press TEST when you have completed your adjustment.

The test tone halts.

Notes

- You cannot enter test mode if headphones are connected to the PHONES jack. Remove the headphones from the PHONES jack.
- You cannot adjust speaker volumes if the "SOUND 1 SPEAKER SET" parameter on the set menu is set to NONE.
- You cannot adjust the subwoofer level if the "1D BASS" parameter in "SOUND 1 SPEAKER SET" in the set menu is set to FRNT.
- If you select "BASIC 1 SETUP" in the set menu and then select "SET", speaker levels change in response to any changes you make in "BASIC 1 SETUP".



- Depending on the source the unit is reproducing, the speaker levels set with the test tone may not be to your liking. If this is the case, adjust the speaker levels while listening to the source.

EDITING SOUND FIELD PARAMETERS

Changing parameter settings

The initial sound field program settings will provide you with an excellent listening experience as they are. But you can create an original listening environment by altering some settings.

Note

- The editable parameters vary depending on the sound field program you select. Refer to the explanation for the parameter.

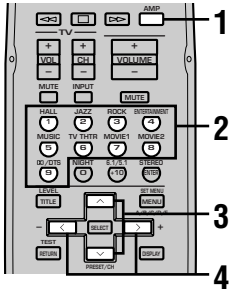

- Repeat steps 2 through 4 if you wish to alter other parameters.

Note

- You cannot change parameter values when “OPTION 2 MEM. GUARD” is set to “ON”. If you want to change the parameter values, set “OPTION 2 MEM. GUARD” to “OFF” (see page 45).

- Press AMP.



- Select the sound field program you want to adjust.

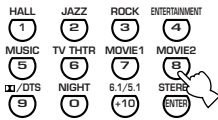

- Press ^ / v to select the parameters.

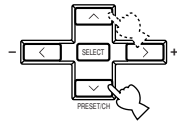

- Press </> to change the parameter value.

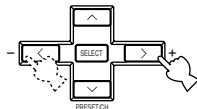

- If you press and hold </> to change the parameter value, the front panel display automatically stops at the factory preset parameter momentarily.

Sound field parameter descriptions

You can adjust the values of certain digital sound field parameters so the sound fields are recreated accurately in your listening room. Not all of the following parameters are found in every program.

■ DSP LEVEL

Function: This parameter adjusts the level of all the DSP effect sounds within a narrow range.

Description: Depending on the acoustics of your listening room, you may want to increase or decrease the DSP effect level relative to the level of the direct sound.

Control Range: -6 dB to +3 dB

■ DELAY

Function: This parameter changes the apparent distance from the source sound by adjusting the delay between the direct sound and the first reflection heard by the listener.

Description: The smaller the value, the closer the sound source seems to the listener. The larger the value, the farther it seems. For a small room, set to a small value. For a large room, set to a large value.

Control range: 1 – 99 msec

For 5ch Stereo

Function: These parameters adjust the volume level for each channel in 5-channel stereo mode.

Control range: 0 to 100%

■ CT LEVEL (Center level)

■ SL LEVEL (Surround left level)

■ SR LEVEL (Surround right level)

For PRO LOGIC II Music

■ PANORAMA

Function: Extends the front stereo image to include the surround speakers for a wraparound effect.

Choices: OFF/ON, initial setting is OFF.

■ DIMENSION

Function: Gradually adjusts the sound field either towards the front or towards the rear.

Control range: -3 (towards the rear) to +3 (towards the front), initial setting is STD (standard).

■ CT WIDTH (Center width)

Function: Adjusts the center image from all three front speakers to varying degrees. A larger value adjusts the center image towards the front left and right speakers.

Control range: 0 (center channel sound is output only from center speaker) to 7 (center channel sound is output only from front left and right speakers), initial setting is 3.

TROUBLESHOOTING

Refer to the chart below when this unit does not function properly. If the problem you are experiencing is not listed below or if the instruction below does not help, set this unit to standby mode, disconnect the power cord, and contact the nearest authorized YAMAHA dealer or service center.

■ General

Problem	Cause	Remedy	Refer to page
This unit fails to turn on when STANDBY/ON (or SYSTEM POWER) is pressed, or enters in standby mode soon after the power has been turned on.	The power cord is not connected or the plug is not completely inserted.	Connect the power cord firmly.	–
	The protection circuitry has been activated.	Make sure all speaker wire connections on this unit and on all speakers are secure and that the wire for each connection is not touching anything other than its respective connection.	16 – 17
	This unit has been exposed to a strong external electric shock (such as lightning and strong static electricity).	Set this unit in standby mode, disconnect the power cord, plug it back in after 30 seconds, then use it normally.	–
No sound.	Incorrect input or output cable connections.	Connect the cables properly. If the problem persists, the cables may be defective.	9 – 17
	No appropriate input source is selected.	Select an appropriate input source with INPUT ◀ / ▶ or 6CH INPUT (or the input selector buttons).	24
	The speaker connections are not secure.	Secure the connections.	16 – 17
	The front speakers to be used have not been selected properly.	Select the proper front speakers with SPEAKERS A/ B/OFF.	24
	The volume is turned down.	Turn up the volume.	23
	The sound is muted.	Press MUTE or any operation buttons of this unit to cancel a mute and adjust the volume.	–
	The signals this unit cannot reproduce are being received from a source component e.g.: a CD-ROM.	Play a source whose signals this unit can reproduce.	–
The sound suddenly goes off.	The protection circuitry has been activated because of a short circuit, etc.	Check that the speaker wires are not touching each other and then turn the unit back on.	–
	The sleep timer has turned the unit off.	Turn on the power, and play the source again.	–
	The sound is muted.	Press MUTE or any operation buttons on the unit to cancel a mute and adjust the volume.	–
No sound / weak sound from particular speakers.	Incorrect cable connections.	Connect the cables properly. If the problem persists, the cables may be defective.	16
No sound from the effect speakers.	The sound effect is switched off.	Press STEREO to turn it on.	–
	A Dolby Surround, Dolby Digital or DTS decoding program is being used with material not encoded with Dolby Surround, Dolby Digital or DTS.	Select another sound field program.	27 – 32
	A digital signal with a sampling frequency of greater than 48 kHz is input to this unit.		–

Problem	Cause	Remedy	Refer to page
No sound from the center speaker.	The output level of the center speaker is set to minimum.	Raise the level of the center speaker.	50
	“SOUND 1A CENTER” on the set menu is set to NONE.	Select the appropriate mode for your center speaker.	41
	One of the HiFi DSP programs (1 to 4) has been selected (except for 5ch Stereo).	Select another sound field program.	27 – 32
	The source encoded with a Dolby Digital or DTS signal does not have a center channel signal.		–
No sound from the surround speakers.	The output level of the surround speakers is set to minimum.	Raise the output level of the surround speakers.	50
	A monaural source is being played with program 9.	Select another sound field program.	27 – 32
No sound from the subwoofer.	“SOUND 1D BASS” on the set menu is set to FRNT when a Dolby Digital or DTS signal is being played.	Select SWFR or BOTH.	42
	“SOUND 1D BASS” on the set menu is set to SWFR or FRNT when a 2-channel source is being played.	Select BOTH.	42
	The source does not contain low bass signals (90 Hz and below).		–
Poor bass reproduction.	“SOUND 1D BASS” on the set menu is set to SWFR or BOTH and your system does not include a subwoofer.	Select FRNT.	42
	The speaker mode settings (front, center or surround) on the set menu does not match your speaker configuration.	Select the appropriate position for each speaker based on the size of the speakers in your configuration.	41 – 42
A “humming” sound can be heard.	Incorrect cable connections.	Firmly connect the audio plugs. If the problem persists, the cables may be defective.	–
The volume level cannot be increased, or the sound is distorted.	The component connected to the OUT (REC) jacks of this unit is turned off.	Turn on the power to the component.	–
The sound effect cannot be recorded.	It is not possible to record the sound effect with a recording component.		–
The sound field parameters and some other settings on the unit cannot be changed.	“OPTION 2 MEM. GUARD” in the SET MENU is set to ON.	Select OFF.	–
The unit does not operate properly.	The internal microcomputer has been frozen by an external electric shock (such as lightning or excessive static electricity) or by a power supply with low voltage.	Disconnect the AC power cord from the outlet and then plug it in again after about 30 seconds.	–
“CHECK SP WIRES” appears on the front panel display.	The speaker cables are short circuited.	Make sure all speaker cables are connected correctly.	–

Problem	Cause	Remedy	Refer to page
There is noise interference from digital or radio frequency equipment, or this unit.	This unit is too close to the digital or high-frequency equipment.	Move this unit further away from such equipment.	–
The unit suddenly turns into standby mode.	The internal temperature has become too high and the overheat protection circuitry has been activated.	Wait until the unit cools down and then turn it back on.	–

■ Tuner

Problem		Cause	Remedy	Refer to page
FM	FM stereo reception is noisy.	The characteristics of FM stereo broadcasts may cause this problem when the transmitter is too far away or the antenna input is poor.	Check the antenna connections. Try using a high-quality directional FM antenna.	13
			Use the manual tuning method.	34
	There is distortion, and clear reception cannot be obtained even with a good FM antenna.	There is multipath interference.	Adjust the antenna position to eliminate multipath interference.	–
	The desired station cannot be tuned in with the automatic tuning method.	The station is too weak.	Use a high-quality directional FM antenna. Use the manual tuning method.	– 34
	Previously preset stations can no longer be tuned in.	The unit has been disconnected for a long period.	Preset the stations again.	35
AM	The desired station cannot be tuned in with the automatic tuning method.	The signal is weak or the antenna connections are loose.	Tighten the AM loop antenna connections and orient it for best reception. Use the manual tuning method.	– 34
	There are continuous crackling and hissing noises.	Noises result from lightning, fluorescent lamps, motors, thermostats and other electrical equipment.	Use an outdoor antenna and a ground wire. This will help somewhat, but it is difficult to eliminate all noise.	13
	There are buzzing and whining noises (especially in the evening).	A TV set is being used nearby.	Move this unit away from the TV.	–

■ Remote control

Problem	Cause	Remedy	Refer to page
The remote control does not work nor function properly.	Wrong distance or angle.	The remote control will function within a maximum range of 6 m (20 feet) and no more than 30 degrees off-axis from the front panel.	7
	Direct sunlight or lighting (from an inverter type of fluorescent lamp, etc.) is striking the remote control sensor of this unit.	Reposition this unit.	–
	The batteries are weak.	Replace all batteries.	3
	The remote control code has not correctly set.	Set the remote control code correctly.	48
		Try setting another code of the same manufacturer.	48
Even if the remote control code is correctly set, there are some models that do not respond to the remote control.		–	

RESETTING THE FACTORY PRESETS

If you want to reset all of your unit's parameters for any reason, do the following. This procedure completely resets ALL parameters, including the SET MENU, level, assign, and tuner presets.

Be sure this unit is in standby mode.

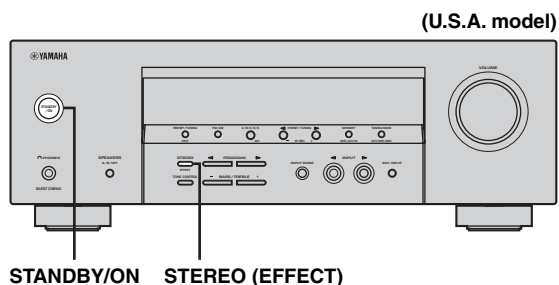

1 With the unit in standby mode, hold down STEREO (EFFECT) on the front panel and press STANDBY/ON.

"PRESET" appears in the front panel display.

If you are using Asia and General model, press PROGRAM ◀/▶ to select "PRESET".



- To cancel the initialization procedure without making any changes, press STANDBY/ON.

2 Press STEREO (EFFECT) to select the desired setting.

RESET To reset the unit to its factory presets.
CANCEL To cancel without making any changes.

3 Press STANDBY/ON to confirm your selection.

If you selected "RESET", the unit is reset to its factory presets and switches to standby mode.

If you selected "CANCEL", the unit switches to

GLOSSARY

■ CINEMA DSP

Since the Dolby Surround and DTS systems were originally designed for use in movie theaters, their effect is best felt in a theater having many speakers and designed for acoustic effects. Since home conditions, such as room size, wall material, number of speakers, and so on, can differ so widely, it's inevitable that there are differences in the sound heard as well. Based on a wealth of actually measured data, YAMAHA CINEMA DSP uses YAMAHA original sound field technology to combine Dolby Pro Logic, Dolby Digital and DTS systems to provide the visual and audio experience of movie theater in the listening room of your own home.

■ Dolby Digital

Dolby Digital is a digital surround sound system that gives you completely independent multi-channel audio. With 3 front channels (left, center, and right), and 2 surround stereo channels, Dolby Digital provides 5 full-range audio channels. With an additional channel especially for bass effects, called LFE (low frequency effect), the system has a total of 5.1 channels (LFE is counted as 0.1 channel).

By using 2-channel stereo for the surround speakers, more accurate moving sound effects and surround sound environment are possible than with Dolby Surround. The wide dynamic range (from maximum to minimum volume) reproduced by the 5 full-range channels and the precise sound orientation generated using digital sound processing provide listeners with previously unheard of excitement and realism.

With this unit, any sound environment from monaural up to a 5.1-channel configuration can be freely selected for your enjoyment.

■ Dolby Pro Logic II

Dolby Pro Logic II is an improved technique used to decode vast numbers of existing Dolby Surround software. This new technology enables a discrete 5-channel playback with 2 front left and right channels, 1 center channel, and 2 surround left and right channels (instead of only 1 surround channel for conventional Pro Logic technology). A music mode is also available for 2-channel sources in addition to the movie mode.

■ Dolby Surround

Dolby Surround uses a 4 channel analog recording system to reproduce realistic and dynamic sound effects: 2 front left and right channels (stereo), a center channel for dialog (monaural), and a surround channel for special sound effects (monaural). The surround channel reproduces sound within a narrow frequency range. Dolby Surround is widely used with nearly all video tapes and laser discs, and in many TV and cable broadcasts as well. The Dolby Pro Logic decoder built into this unit employs a digital signal processing system that automatically stabilizes the volume on each channel to enhance moving sound effects and directionality.

■ DTS (Digital Theater Systems) Digital Surround

DTS digital surround was developed to replace the analog soundtracks of movies with a 6-channel digital sound track, and is now rapidly gaining popularity in movie theaters around the world. Digital Theater Systems Inc. has developed a home theater system so that you can enjoy the depth of sound and natural spatial representation of DTS digital surround in your home. This system produces practically distortion-free 6-channel sound (technically, a left, right and center channels, 2 surround channels, plus an LFE 0.1 channel as a subwoofer, for a total of 5.1 channels).

■ ITU-R

ITU-R is the radio communication sector of the ITU (International Telecommunication Union). ITU-R recommends a standard speaker placement which is used in many critical listening rooms, especially for mastering purposes.

■ LFE 0.1 channel

This channel is for the reproduction of low bass signals. The frequency range for this channel is 20 Hz to 120 Hz. This channel is counted as 0.1 because it only enforces a low frequency range compared to the full-range reproduced by the other 5 channels in a Dolby Digital or DTS 5.1 channel systems.

■ Matrix 6.1

The unit incorporates Matrix 6.1 decoder for Dolby Digital and DTS multi-channel software that enables 6.1-channel reproduction by adding the surround back channel to existing 5.1-channel format. (The surround back channel is created from surround left and right channels, and outputted from virtual surround back speaker.) With this additional channel, you can experience more dynamic and realistic moving sound especially with scenes with "fly-over" and "fly-around" effects.

■ PCM (Linear PCM)

Linear PCM is a signal format under which an analog audio signal is digitized, recorded and transmitted without using any compression. This is used as a method of recording CDs and DVD audio. The PCM system uses a technique for sampling the size of the analog signal per very small unit of time. Standing for "pulse code modulation", the analog signal is encoded as pulses and then modulated for recording.

■ Sampling frequency and number of quantized bits

When digitizing an analog audio signal, the number of times the signal is sampled per second is called the sampling frequency, while the degree of fineness when converting the sound level into a numeric value is called the number of quantized bits.

The range of rates that can be played back is determined based on the sampling rate, while the dynamic range representing the sound level difference is determined by the number of quantized bits. In principle, the higher the sampling frequency, the wider the range of frequencies that can be played back, and the higher the number of quantized bits, the more finely the sound level can be reproduced.

■ SILENT CINEMA

YAMAHA has developed a natural, realistic sound effect DSP algorithm for headphones.

Parameters for headphones have been set for each sound field so that accurate representations of all the sound field programs can be enjoyed using headphones.

■ Virtual CINEMA DSP

YAMAHA has developed a virtual CINEMA DSP algorithm that allows you to enjoy DSP sound field surround effects even without any surround speakers by using virtual surround speakers.

It is even possible to enjoy virtual CINEMA DSP using a minimal 2-speaker system that does not include a center speaker.

SPECIFICATIONS

AUDIO SECTION

- Minimum RMS Output Power for Front, Center, Surround
1 kHz, 0.9% THD, 6 Ω/8 Ω 110 W
- DIN Standard Output Power
[Europe model]
1 kHz, 0.7% THD, 4 Ω 105 W
- Maximum Power
[China, Korea and General models]
1 kHz, 10% THD, 6 Ω 110 W
- Dynamic Power
[U.S.A. and Canada models] (Impedance Selector: 8 Ω)
(IHF, 8/6/4/2 Ω) 120/140/160/180 W
[Other models]
(IHF, 6/4/2 Ω) 105/135/165 W
- Frequency Response
CD, etc. to Front L/R 10 Hz to 100 kHz, -3 dB
- Total Harmonic Distortion
1 kHz, 50 W, 6 Ω, Front L/R 0.06%
- Signal to Noise Ratio (IHF-A Network)
CD (250 mV, shorted) to Front L/R, Effect Off ≥ 100 dB
- Residual Noise (IHF-A Network)
Front L/R 150 μV or less
- Channel Separation (1 kHz/10 kHz)
CD, etc. (5.1 kΩ terminated) to Front L/R ≥ 60 dB/ ≥ 45 dB
- Tone Control (Front L/R)
BASS Boost/Cut ± 10 dB/100 Hz
TREBLE Boost/Cut ± 10 dB/20 kHz
- Phones Output 400 mV/470 Ω
- Input Sensitivity
CD, etc. 200 mV/47 kΩ
6CH INPUT 200 mV/47 kΩ
- Output Level
OUT (REC) 200 mV/1.2 kΩ
OUTPUT SUBWOOFER 4 V/1.2 kΩ

VIDEO SECTION

- Video Signal Type NTSC or PAL
- Composite Signal Level 1 V_{p-p}/75 Ω
- Signal to Noise Ratio ≥ 50 dB
- Frequency Response (MONITOR OUT)
Video Signal 5 Hz to 10 MHz, -3 dB
Composite Signal 5 Hz to 60 MHz, -3 dB

FM SECTION

- Tuning Range
[U.S.A. and Canada models] 87.5 to 107.9 MHz
[Other models] 87.50 to 108.00 MHz
- 50 dB Quieting Sensitivity (IHF, 100% mod.)
Mono 2.8 μV (20.2 dBf)
- Signal to Noise Ratio (IHF)
Mono/Stereo 73 dB/70 dB
- Harmonic Distortion (1 kHz)
Mono/Stereo 0.5%/0.5%

AM SECTION

- Tuning Range 530/531 to 1710/1611 kHz

GENERAL

- Power Supply
[U.S.A. and Canada models] AC 120 V/60 Hz
[Australia model] AC 240 V/50 Hz
[U.K. and Europe models] AC 230 V/50 Hz
[Korea model] AC 220 V/60 Hz
[China model] AC 220 V/50 Hz
[Asia and General models] ... AC 110-120 V/220-240 V, 50/60 Hz
- Power Consumption
[U.S.A. and Canada models] 240 W/320 VA
[Other models] 240 W
- Standby Power Consumption
[U.S.A. and Canada models] 0.5 W
[Other models] 0.7 W
- Dimensions (W x H x D) 435 x 151 x 315 mm
(17-1/8" x 5-15/16" x 12-7/16")
- Weight 9 kg (19 lbs 13 oz)

*Specifications are subject to change without notice.

LIST OF REMOTE CONTROL CODES

TV

Admiral	292 293
Aiwa	294 276 283 284
Akai	295 296
Alba	296
AOC	297
Bell&Howell	292
Bestar	298
Blaupunkt	229 222
Blue sky	298
Brandt	223
Brocsonic	297
Bush	296
Clatronic	298
Craig	224
Croslex	225
Curtis Mathis	297 226
Daewoo	297 298 224 227 228
Daytron	239
Dual	298
Emerson	297 224 239 232
Ferguson	223 265 266
First line	298
Funai	277 278
Fisher	295 233
Fraba	298
GE	293 297 234 235 236
LG/Goldstar	297 298 239 237
Goodmans	296 298 223
Grundig	229 238 249
Hitachi	297 239 242 243 285
ICE	296
Irradio	296
Itt/Nokia	244 245
JC Penny	293 297 234 237
JVC	296 246 247 286
Kendo	298
KTV	297 239
Loewe	298 248
LXI	293 297 225 226 233
Magnavox	297 225 239
Matsui	295
Mitsubishi	299 297 259 287
NEC	297 252 282
Nokia	244 245
Nokia Oceanic	245
Nordmende	265 266
Onwa	296
Panasonic	234 235 236 253 288 211
Philco	297 225 239
Philips	225
Pioneer	226 235 254 255 268
Portland	297 256
Quasar	234 235
Radio Shack	299 293 297
RCA	293 297 234 256 257 258
SABA	223 269 265 266
Samsung	297 239 248 262 275
Sanyo	295 233 279 272 273 274 212
Schneider	296
Scott	297
Sharp	292 239 232 213
Siemens	229
Signature	292
Sony	263 214
Sylvania	297 225
Telefunken	269 264 265 266

Thomson	223 266
Toshiba	292 226 267 215
Videch	297 242
Wards	297 239 232
Yamaha	299 292

VCR

Admiral	395
Aiwa	396 397 398 329
Akai	322 323 324
Audio Dynamic	392 394
Bell&Howell	393
Blaupunkt	325 326
Brocsonic	327
Bush	322
Canon	325 328
CGM	396 332
Citizen	396
Craig	396
Curtis Mathis	397 328 333
Daewoo	328 334 335
DBX	392 394
Dimensia	333
Emerson	327 334
Fisher	393 336
Funai	397
GE	328 333 387
LG/Goldstar	396 388
Goodmans	334 337
Grundig	332 338
Hitachi	325 333 349 342 343
Instant Replay	325 328
Itt/Nokia	393
JC Penny	392 393 394 328 333 349
JVC	392 394 344 345 346 347
Kendo	396
Kenwood	392 394 396
Loewe	396 337
Luxor	395
LXI	393 396 397 336 349
Magnavox	325 326 328
Marantz	392 394
Marta	396
Matsui	396
Memorex	328 336
Minolta	333 349
Mitsubishi	399 344 348 359 352 353
Multitech	397 348 354
NEC	392 394 344 383
Nokia	393 395
Nokia Oceanic	395
Okano	323
Olympic	325 328
Orion	327
Panasonic	325 328 355 378 384 385 386
Pentax	333 349
Philco	325 328
Philips	325 326 328 337 356 357
Phonola	337
Pioneer	325
Quasar	325 328
RCA/Proscan	325 326 328 333 335 349 358 369
Realistic	393 397 328 336 359 362
Samsung	354 358 363 364 365 366
Sansui	394
Sanyo	393 336 367
Schneider	337
Scott	399 335 336 348 359 352 354 358
Selec	322

Sharp	395 362 382
Siemens	393
Signature 2000	395 397
Sony	368 379 372 373 374 375
Sylvania	397 325 326 328
Symphonic	397
Tandberg	334
Tashiro	396
Tatung	392 394
Teac	392 394 397
Technics	325 328
Telefunken	376 377
Thorn	393 396
Toshiba	335 369 389
Universum	396 327 376
W.WHouse	396
Wards	395 396 336 362
Yamaha	399 392 393 394

DVD player

Denon	623 624
Funai	625
Hitachi	626
JVC	627
Kenwood	628
Mitsubishi	629
Onkyo	632 633 634
Panasonic	623 635
Philips	699 647
Pioneer	636 637 638
RCA	639
Samsung	642
Sharp	643
Sony	644
Toshiba	634
LG/Goldstar	645
Thomson	646
Yamaha	699 622 623 647

MD Recorder

Yamaha	599
--------	-----

CD player

Yamaha	199
--------	-----

CD Recorder

Yamaha	499
--------	-----



©2005 YAMAHA CORPORATION All rights reserved.

YAMAHA ELECTRONICS CORPORATION, USA 6660 ORANGETHORPE AVE., BUENA PARK, CALIF. 90620, U.S.A.
YAMAHA CANADA MUSIC LTD. 135 MILNER AVE., SCARBOROUGH, ONTARIO M1S 3R1, CANADA
YAMAHA ELECTRONIK EUROPA G.m.b.H. SIEMENSSTR. 22-34, 25462 RELLINGEN BEI HAMBURG, GERMANY
YAMAHA ELECTRONIQUE FRANCE S.A. RUE AMBROISE CROIZAT BP70 CROISSY-BEAUBOURG 77312 MARNE-LA-VALLEE CEDEX02, FRANCE
YAMAHA ELECTRONICS (UK) LTD. YAMAHA HOUSE, 200 RICKMANSWORTH ROAD WATFORD, HERTS WD18 7GQ, ENGLAND
YAMAHA SCANDINAVIA A.B. J A WETTERGRENS GATA 1, BOX 30053, 400 43 VÄSTRA FRÖLUNDA, SWEDEN
YAMAHA MUSIC AUSTRALIA PTY, LTD. 17-33 MARKET ST., SOUTH MELBOURNE, 3205 VIC., AUSTRALIA

YAMAHA CORPORATION
Printed in China ◀ WE59680